

PRO DRY

Instruction & Technical Manual

W WALKER
FILTRATION

ULTIMATE FILTRATION TECHNOLOGY

Walker Filtration Ltd, Spire Road, Glover East,
Washington, Tyne & Wear NE37 3ES ENGLAND

Table of Contents

	Page:
1. Introduction	3
2. Safety	4
3. Description of the dryer's main components	6
4. Explanation of the dryer's main components	7
5. Connecting the pre-filter to the dryer	8
5.2 Reconfiguration of the inlet and outlet ports	9
5.3 Installing the dryer in a horizontal orientation	10
6. Installation	11
7. Electrical supply	12
8. Energy management and PC interfacing	14
9. Operation	24
10. Start up	25
11. Service and fault diagnosis	26
12. Dryer troubleshooting	35
13. Dryer sizing table	37
14. Environmental conditions	39
15. Warranties and liabilities	40
16. EC Declaration of conformity	41

1. Introduction

The product to which this manual refers must not be supplied, installed, used, operated or serviced until the contents of the manual have been fully read and understood by all relevant personnel.

This manual, and in particular the safety information, should be kept at the place of installation of the product. All relevant personnel must strictly follow instructions given in the manual.

When contacting Walker Filtration regarding this product or manual, please have the following information available:







- Serial number:
- Date of commissioning:

The serial number can be found on the identification plate located at the upper right hand side of the unit and this information should be copied into this manual for future use.

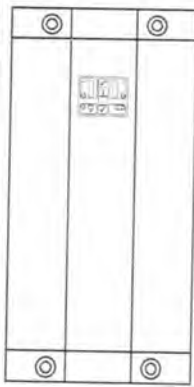
The dryer is delivered in protective packaging. Take care when transporting, loading and unloading the unit.

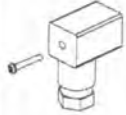
The dryer is delivered configured for operation at 7 barg. It is important to ensure that the correct plug is fitted applicable to the operating pressure. See table on page 38 for further information.

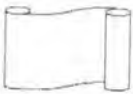
The dryer package includes:

				
	PRE FILTER	TUBING	DIN PLUG	CONNECTING KIT
				
DRYER	WARRANTY	CERTIFICATE OF CONFORMITY	INSTRUCTION MANUAL	

2. Safety

Walker Filtration explicitly excludes all responsibility and liability for damage and/or injury caused by failure to follow the instructions described in this manual, or by failing to pay necessary attention when operating handling or servicing this product, even if not specifically stated in individual cases.

The unit must be used for its intended purpose. The heatless-regenerating adsorption dryer is designed and manufactured exclusively for drying of compressed air within conditions as described in section 11 of this manual. Any other use of the unit will be considered inappropriate and Walker Filtration shall not be liable, where this is permitted under law, for any damage incurred as a result of misuse.

The following symbols give indication of potential hazard. Appropriate measures must be taken to reduce risk to any user or operator of the machine wherever such hazard exists.



Warning:
Risk of Danger



Caution:
Risk of High Pressure



Caution:
Risk of Electric Shock

The following safety guidelines must be strictly observed:

- Leave this manual at the place of installation of the product.
- It is essential that only Walker Filtration or their appointed agents carry out maintenance and servicing work.
- Users, maintenance and servicing personnel must be familiar with:
 - accident prevention regulations
 - safety information (general and specific to the unit)
 - safety devices of the unit
 - measures to be taken in case of emergency
 - allow only suitably trained persons to be involved with installation, start-up, operation, servicing and maintenance of the product.
- It is the responsibility of the installer to ensure that the pipe work to and from the dryer is suitable, in accordance with applicable legislation and subject to inspection and testing prior to being put into service. All piping must be adequately supported.
- Before carrying out any maintenance or servicing work the unit must be taken out of operation. Users and others will be exposed to risk if work is carried out whilst the unit is running. This means electrical disconnection plus isolation from the compressed air supply and full depressurisation.
- Only trained and competent persons familiar with the electrical requirements of the unit as laid out in this manual and electrical safety rules and regulations should be allowed to carry out work on the electrical components and power supply to the unit.
- When carrying out any work on the unit, use only correctly sized appropriate tools in good condition.
- Only use original spare parts and accessories from the manufacturer. There is no guarantee that non-original parts have been designed and manufactured to meeting the safety and operational requirements of the unit. Walker Filtration assume no liability for any equipment malfunction resulting from the use of non-approved parts.
- If carrying out installation work above head height, use suitable and safe working platforms or other means of working access.
- Do not make any constructional changes to the product. Any changes or modifications may only be carried out by the manufacturer, Walker Filtration.
- Any faults or defects that could affect safety must be put right fully before using the unit.
- Used items and materials must be disposed of in the correct manner, complying with local laws and regulations, in particular the desiccant cartridge.

⚠ 3. Description of the dryer's main components

The figure below shows the main elements of a typical dryer unit with the pre-filter removed for clarity of view.

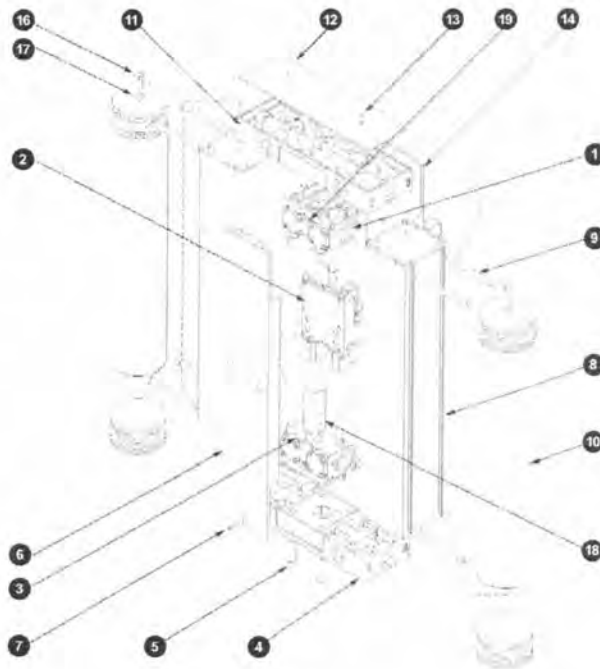

- | | | | |
|---|---------------------------------|----|-------------------------------------|
| 1 | Top valve assembly | 10 | Desiccant cartridge c/w dust filter |
| 2 | Control unit | 11 | Multiport manifold |
| 3 | Bottom valve assembly | 12 | Top cover |
| 4 | Bottom mounting block | 13 | Top cover fixing screw |
| 5 | Bottom valve fixing bolt | 14 | Rear panel |
| 6 | Front panel | 15 | DIN connector |
| 7 | Front panel fixing screw | 16 | Banjo fixing bolt |
| 8 | Pressure housing | 17 | Pressure seal |
| 9 | Pressure housing retaining bolt | 18 | Exhaust silencer |
| | | 19 | Purge plug |

4. Explanation of the dryer's main components

4.1 Control unit, item ref. 2 on page 6

The top and bottom valve blocks are operated by solenoids within the control unit that determine the pressure and direction of air flow into the desiccant cartridges.

4.2 Multiport manifold, item ref. 11 on page 6

The dryer is supplied as standard with inlet and outlet ports configured left to right as viewed from the front of the unit. There are several optional porting arrangements available by repositioning of port plugs. See also Section 5.2.

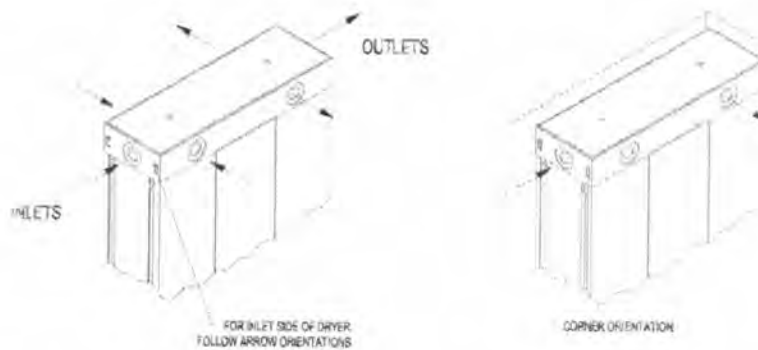

4.3 Desiccant cartridge c/w dust filter

The cartridges contain the agent (desiccant) that has been developed for the drying of compressed air. The desiccant is housed in a clear tube that has a holder permeable to air at both ends. Located in the top of each cartridge is a 1-micron filter for removal of residual dust from the desiccant. The length of the cartridge varies with the flow capacity of the dryer.

4.4 Pressure housing

The cartridges are contained within an extruded aluminium pressure housing and pressure retaining end plates. Process pressure and flow through each desiccant cartridge is controlled by means of top and bottom valve blocks located between the two pressure housings. The regenerating air flow (purge) is controlled by means of a small orifice plug located externally (front, central) on the top valve block and is accessible with the front panel removed.

5. Connecting the pre-filter to the dryer

1. Split union and tighten one end into dryer, the other in to the filter outlet, observing flow direction.
2. Offer the filter union to the dryer union and engage the union. Tighten as necessary and observe alignment.
3. Fit 4mm (5/32") black tubing to filter and drain valve inlet.
4. Pipe away condensate with 4mm (5/32") tubing from drain outlet. Ensure condensate is drained into an oil/water separator.
5. Fit any further filtration or ancillary equipment.
6. Drain kits to be supplied with dryer and comprise of the following:- Swivel elbow adapter and 4mm tubing.

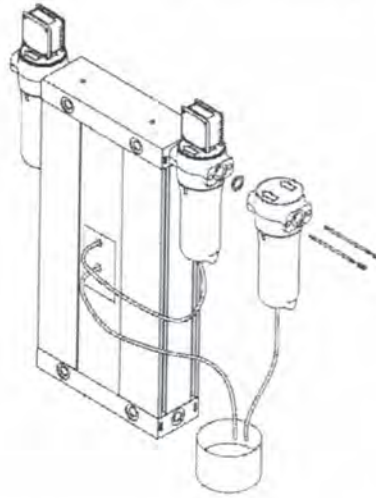

All tubing should be secured up to the point of drain to prevent whipping during discharge.

5.1 Recommendation

It is recommended that a bypass line including filter is installed.

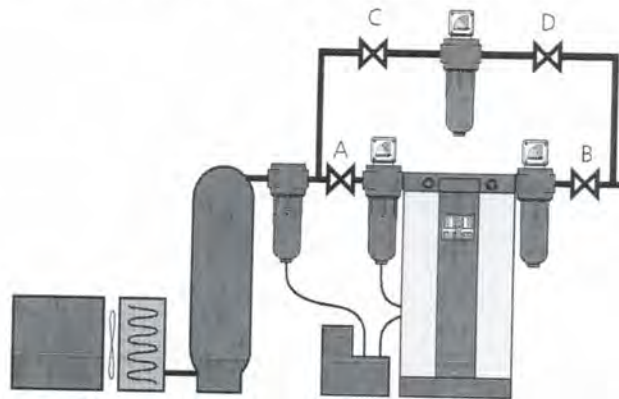
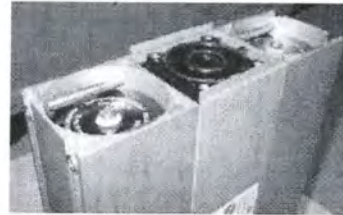

Figure 5.1

5.2 Reconfiguration of inlet and outlet ports



1. Port configuration as delivered: 3 inlet options left hand side of dryer as viewed from front.



5. Dryer with multiport manifold removed.



2. Remove top cover by means of 2 fixing screws.



6. Rotate multiport manifold through 180° and replace by means of 4 fixing bolts. Ensure 2 'O' rings in valve block are properly seated.



3. Dryer with top cover removed.



7. Replace top cover by means of 2 fixing screws.



4. Remove multiport manifold by means of 4 fixing bolts.

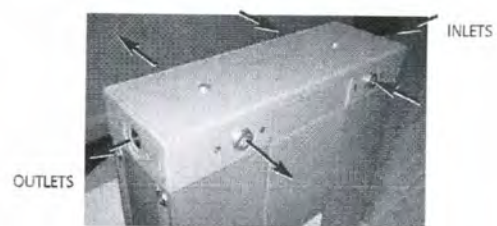

8. Port configuration following procedure above.

5.3 Installing the dryer in a horizontal orientation



1. Inlet filter as fitted to dryer in vertical orientation. Mounting kit allows filter to couple directly to multiport manifold.

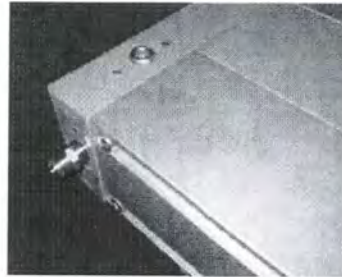

2. For horizontal orientation, dryer must be suitably supported in flat plane only as shown. A nipped adaptor (not supplied) is required for connection of the pre-filter.













3. Inlet filter must be fitted vertically and coupled as closely as possible to inlet port on multiport manifold.

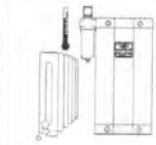

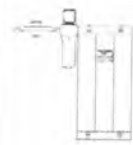
4. Dryer in horizontal plane. Consideration must be given to supporting and to clearance for removal of inlet filter bowl.

6. Installation requirements

Correct	Wrong	Correct	Wrong
< 35°C	> 35°C		
< 16 barg	< 4 barg		
≥ 12 V	< 12 V		
			
			
			

⚠ 7. Electrical supply

7.1 Connection

1. The dryer is designed to operate on either an AC or DC supply voltage.

Ensure only one power source is connected at any one time, and it is connected to the correct socket. Cover supplied must be fitted to the power connection not in use.

2. The power supply is to the DIN plug.

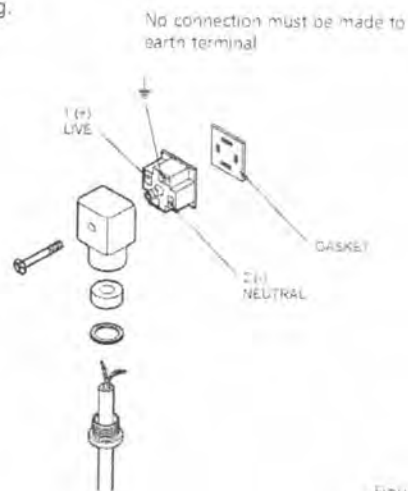

3. The dryer is double insulated therefore no earth is required.
4. Suitable external fuse connection must be provided.
5. The cable selection must suit local installation regulations and be appropriate to power consumption.

Figure 6.1

Supply	Amp
12 VDC	0.8
24 VDC	0.4
100 VAC	0.16
115 VAC	0.14
230 VAC	0.07
240 VAC	0.067

7.2 DIN plug drawings

Voltages: 100 to 240 VAC

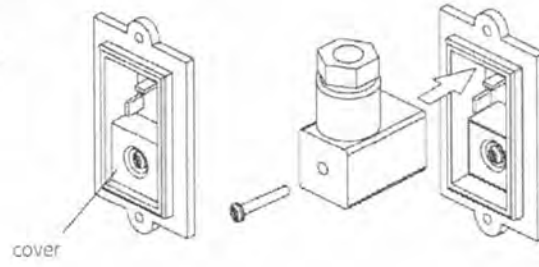

Voltages: 12 to 24 VDC

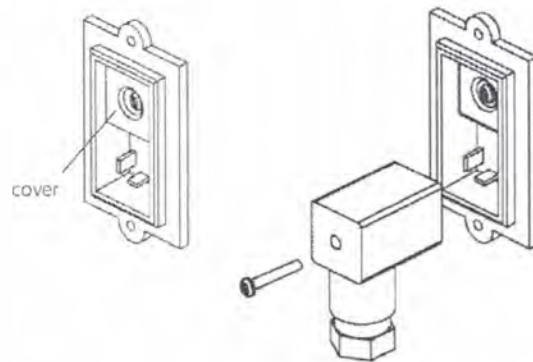

8. Energy management and PC interfacing

8.1 Interfacing the controller with a PC

8.1.1 Introduction to the software

The dryer controller has the ability to interface with a PC. This gives the user or the service engineer the opportunity to interrogate the dryer to check the following:

- Operating stage times
- Service warnings
- Operating history
- Alarm settings
- Fault history
- Fault and service history
- Real Time displays
- Setting Energy Management Parameters – contact Walker Filtration for details



Connecting the PC to the controller

8.1.2 PC requirements

Controller Application software: Windows 95, Windows 98, Windows 2000, Windows ME & Windows XP.

8.1.3 Installing the application software

Simply load the CD into the PC and the software will automatically load-up and complete installation.

The Walker Filtration icon will be visible on the desktop.

8.1.4 Connecting the PC to the controller

Ensure that power to controller is isolated.

Access to the controller is by removing the screw on the front panel, and removing the panel.

Using the lead supplied connect the serial port connector to the PC.

The RJ45 connector is located on the underside of the controller.

Remove the blanking plug taking care not to lose it and connect the RJ45 connector with the latch to the front of the dryer.

Controller shown in the inverted position for reasons of clarity

1. Condensate solenoid valve
2. Tower 1 solenoid pilot valve
3. Tower 2 solenoid pilot valve
4. AC&DC supply DIN connections
5. Energy management DIN connection
6. Controller clear LED cover
7. RJ45 Software connection
8. Alarm DIN connection

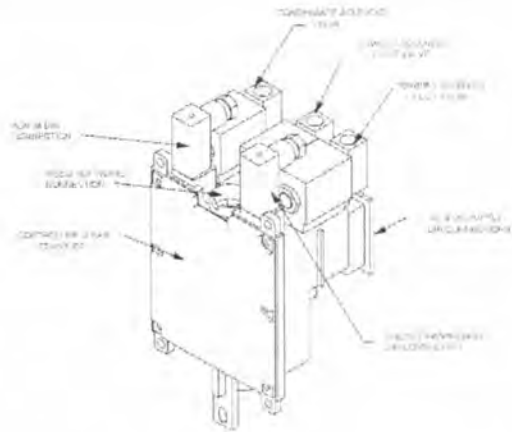

8.1.5 Starting the program

Launch the dryer application software by either double clicking the icon which will appear on the PC desktop or by clicking: -

Start> Programs> Dryer application software > Dryer application software



The following window will appear: -

If the language is not as you require it, then click the appropriate national flag, and the next time the application software starts the text will be in your requested language.

8.1.6 Establish communication: -

Click the 'Establish communication' switch on the screen, which will look for the link between the PC and the dryer controller.

The serial number from the software must match the serial number marked on the controller.

If communication cannot be made, a warning will appear at the bottom of the screen.

This may be due to the following: -

- Poor connections to the controller
- Controller switched off
- Application software/controller serial number mismatch



8.1.7 Read dryer

Once communication has been established, click the "Read dryer" button on the screen. This will then display the current controller settings.

8.1.8 Program dryer

It is possible to change some of the controller settings from the factory default values. This should only be done by a qualified service engineer.

To program the dryer controller:-

- Click the box you wish to change
- Overwrite the settings as required (Note: Stage Times are in 1 second intervals)
- Click 'Program dryer' (Note: a warning will appear asking to confirm the change)
- Click to confirm
- Click 'Real time view' to check set up (See section 8.1.9)

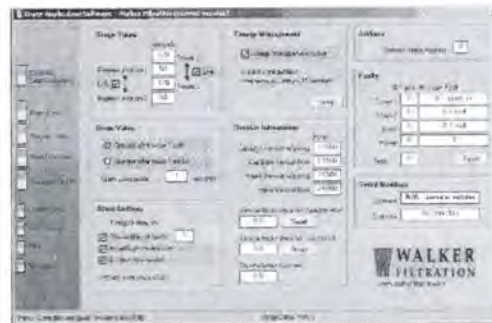

8.1.8.1 Stage Times: -

- Tower 1 & Tower 2 – Indicates the time that a tower is depressurised.
- Re-pressurisation – Indicates the re-pressurisation time.
- Link – Enables or disables the tower 1 & tower 2 settings to be linked.

8.1.8.2 Drain valve: -

There are two options for drain valve operation and a programmable pulse time setting.

Please select: -

- Drain valve operation after Tower 1 has re-pressurised or drain valve operation after Tower 1 and Tower 2 have re-pressurised.
- Drain valve pulse time measured in seconds. This sets the drain valve operation time.

8.1.8.3 Alarm settings: -

Allows the service engineer to toggle and adjust the remote alarm activation values from the default values. (See section 8.1.8.9 for further information)

8.1.8.4 Energy Management: -

Allows the user to set application parameters to save energy during periods of low demand. See section 8.2 Energy Management for a detailed explanation of Energy Management setup options.

8.1.8.5 Service information: -

Indicates the default settings at which the cartridge and valve service indicators will illuminate. The service history of the machine is logged in terms of hours run since the last service and the total service hours from new installation. The re-set buttons provide an alternative method of resetting service hours as opposed to using the re-set disc provided with the service kit.

8.1.8.6 Address: -

Indicates the network address of the dryer, should several dryers be operated from a single software license.

8.1.8.7 Faults: -

The first column indicates the number of faults (up to 50 every 30 minutes). The second column indicates the type of fault and the hour it occurred from new installation.

8.1.8.8 Serial numbers -

This indicates the software and dryer controller serial numbers.

8.1.8.9 Remote fault alarm: -

A remote alarm relay is built into the controller. This facilitates the activation of a remote audible or visual indicator. The alarm can be set to activate at the service interval and/or after a pre-defined number of electrical faults.

8.1.9 Real Time View

This screen can be opened by clicking the 'Real Time View' button. A new window will appear animating the dryer controller status in real time. A countdown timer is shown for each stage of the operating cycle.

The following information is shown:

- The stage the controller is at within the cycle for each tower
- LED status
- Power status
- Cartridge service status
- Valve service status
- Alarm status
- Energy management status



8.1.10 Program defaults

This button resets the parameters back to the factory default values.

8.1.11 Load settings

The button allows previously stored settings to be loaded into the controller.

8.1.12 Save settings

This button enables the current settings to be saved for future reference.

8.1.13 Help

This button displays a pop-up screen containing contact details for the vendor.

8.1.14 Simulate

This button displays a pop-up menu that enables certain conditions to be simulated

8.2 Energy Management feature (EM)

8.2.1 Description

The purpose of the energy management feature is to save energy by reducing compressed air consumption during periods of low demand by interrupting the normal purge cycle. This can be activated with a link from the receiver upper and lower pressure switches normally fitted to receivers.

In the case where the compressor is a continually running type or the dryer is remote from the receiver then a dew point dependent switch can be used to activate the energy management feature.

As standard, the energy management feature is supplied activated on all controllers. When connected to an external switching system, the energy management process will become operational. For systems where energy management will not be required, a jumper link is fitted to the supplied DIN plug.

8.2.2 Energy management connection

1. Remove DIN plug from EM connection on controller.
2. Remove blanking plug from cable entry nut on DIN plug.
3. Remove fixing screw and gasket from DIN plug body.
4. Separate DIN plug body internal from cover.
5. Remove jumper wire from pins 1 & 2 on DIN plug body internal.
6. Connect external switching device cable to pins 1 & 2 on DIN plug body internal, ensuring that cable entry nut, washer and seal are in place.
7. Assemble DIN plug body internal into cover and reconnect DIN plug to EM connection on controller, ensuring that screw and gasket are fitted.
8. The controller gives a +5VDC from pin 1 on the EM DIN. Operation of the EM feature is by opening and closing the circuit.
9. Opening the circuit with an appropriate external relay or switch will activate the EM feature.

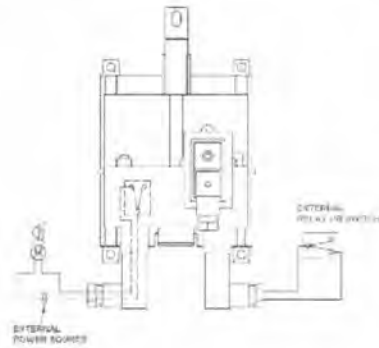

The user must ensure that the EM DIN plug as supplied with jumper wire, or an external switching arrangement is in place before the dryer becomes operational.



Ensure the energy management switching arrangement is in place before activating the EM facility and flowing air through the dryer.

8.2.3 Energy management application selection

For correct energy management operation it is important to select the correct mode of operation for the application.

For applications where the compressor, receiver and the dryer are in the same location linking the controller energy management into the compressor pressure limit switch, an effective method of energy saving is offered.

For applications where the compressor is a continual operating type or the dryer is point of use or is remote from the receiver, then a dew point dependant method of switching should be employed.

This links the operation of the energy management to the outlet dew point from the dryer.

The flow diagram below illustrates the correct selection:

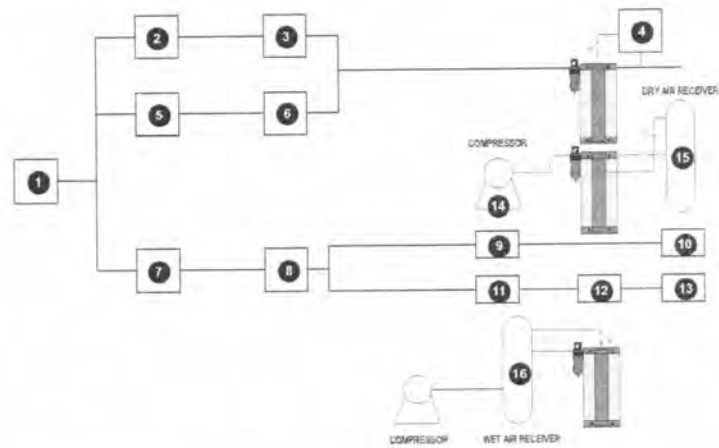

- | | | |
|---|---|---|
| 1 Energy management required | 4 Dewpoint dependant energy management switching | 10 15 second default EM delay |
| 2 Point of use dryer application (remote from compressor) | 7 Dryer directly connected to local compressor and receiver | 11 Wet receiver application |
| 3 Dewpoint dependant energy management switching | 8 Compressor load energy management switching | 12 Input compressor/receiver operating parameters |
| 4 Dewpoint monitoring | 9 Dry receiver application | 13 Calculated EM delay |
| 5 Continuous running compressor | | 14 Compressor |
| | | 15 Dry air receiver |
| | | 16 Wet air receiver |

8.2.4 Connecting the PC to the controller

See 8.1 for connection of the PC to the controller. The energy management active box will be ticked and a default delay of 15 seconds operational. If this figure is considered suitable for the application, no further set up is necessary. If the application requires dedicated settings to be entered, follow the rest of the instructions in this section.

The energy management feature can be deactivated by unticking the box if necessary. Alternatively, the DIN plug with jumper link will override the energy management feature providing it is left in place.

Select dry or wet receiver from the illustration given in the set-up screen by toggling in the appropriate box.

Note: for point of use dryers or constant running dryers utilising dewpoint monitoring the dry receiver system should be activated regardless of installation.

By switching "dryer receiver" this will operate the energy management facility after a 15 seconds delay.

For wet receiver applications switch the wet receiver box. To calculate the necessary delay it is necessary for the installer to input the high and low pressure set points for the compressor switch, the internal volume of the receiver and the flow rate of the dryer. The purpose of the delay is to prevent dryer saturation when using a large receiver with large range of set pressures.

Once the application conditions have been input click "OK" this will return the screen to main application software click "Program Dryer" will set and fix the previously defined conditions.

The RJ45 connection can be removed by using a small screw driver to depress the retaining tang on the connector and withdrawn. Replace the push-in cover and replace the front panel.



8.2.5 Energy management memory retention

Energy savings are made in the dryer by interrupting the normal purge operation during periods of low demand.

To maintain the equilibrium of the dryer towers the dryer has a memory retention feature. This allows the dryer to remember the point in the operating cycle when the energy management feature was activated and return to it to complete the cycle.

8.2.6 From new or service delay

To allow conditioning of the dryer desiccant beds to the optimum condition, a 6-hour delay has been programmed into the controller to delay Energy Management operation from new or from a service. Once this time has elapsed and the energy management facility can then be operated.

8.3 Alarm connection details

To enable the alarm facility it is recommended that a suitable cable is brought into the controller via the rear panel with a grommet. An external power source is required.:

1. Connect the switching pole of an externally powered alarm device to terminals 1 and 2 of alarm DIN connector.
2. With the power removed from the dryer and the alarm lead wired as described in 1 above, remove the cover from the DIN connection marked 'Alarm' and connect the wired DIN connector ensuring the seal and screw are fitted.

Alarm relay rating	3 Amp Max 28 VDC
Alarm connection type	Hirschmann GDS 207 industrial standard DIN connector or equivalent

8.4 Schematic wiring and fault diagrams

8.4.1 General wiring diagram

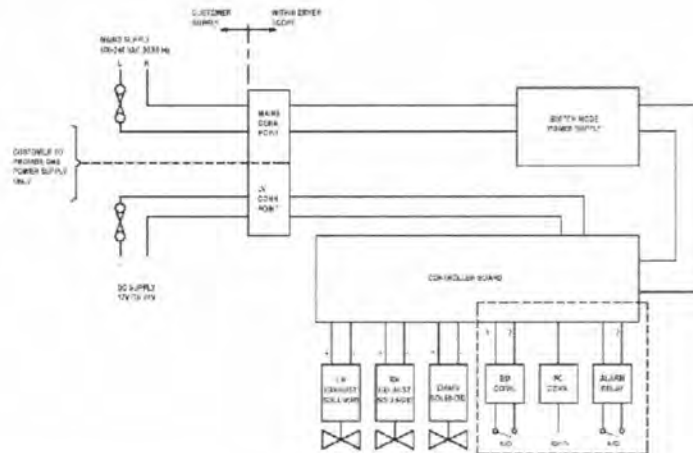

8.4.2 Remote alarm wiring diagram

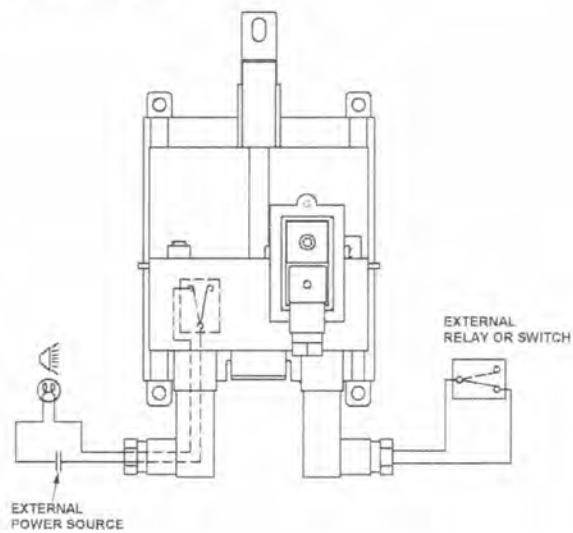

9. Operation

The dryer operation is designed to give smooth, uninterrupted delivery of compressed air to the designated specification.

During the cycle of operation, the first pressure housing is fully pressurised and airflow is directed upwards through the desiccant cartridge, removing moisture from the air during its passage, to the minimum specified dewpoint.

During the drying cycle, a small bleed of dry air (purge) is directed to the opposite pressure housing. This purge air flows down through the desiccant cartridge and to atmosphere by means of an exhaust silencer, thereby effecting regeneration of the desiccant.

After 120 seconds of operation, the cartridge under regeneration is sealed by closing of the exhaust valve and the pressure housing is brought up to full system pressure by the purge air.

After 170 seconds, the pressure in the first housing is released to atmosphere by means of the corresponding exhaust valve and the desiccant cartridge then operates in regeneration mode. The main air flow and drying function is then transferred to the desiccant cartridge that was previously under regeneration.

The cycle of operation continues in this pattern with the cartridges switching alternately between drying and regenerating.

10. Start up

10.1 Procedure

1. Close valves A, B, C and D.
2. Switch on compressor.
3. Open valve A slowly.
4. Check there are no leaks from the dryer.
5. Switch on electric power. All four display panel LED's will flash simultaneously green four times then simultaneously red four times to acknowledge application of power and readiness to function. Observe display panel for one complete cycle. Note: cycle described is factory setting.

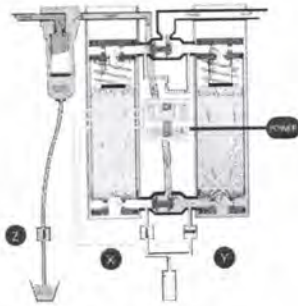
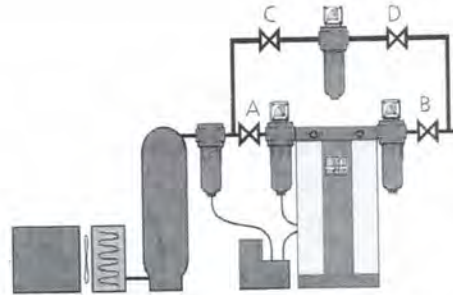

Figure 7.2. Dryer in operation

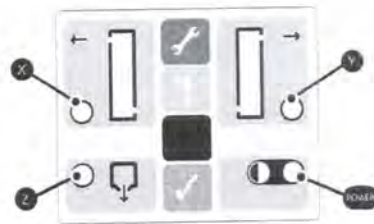
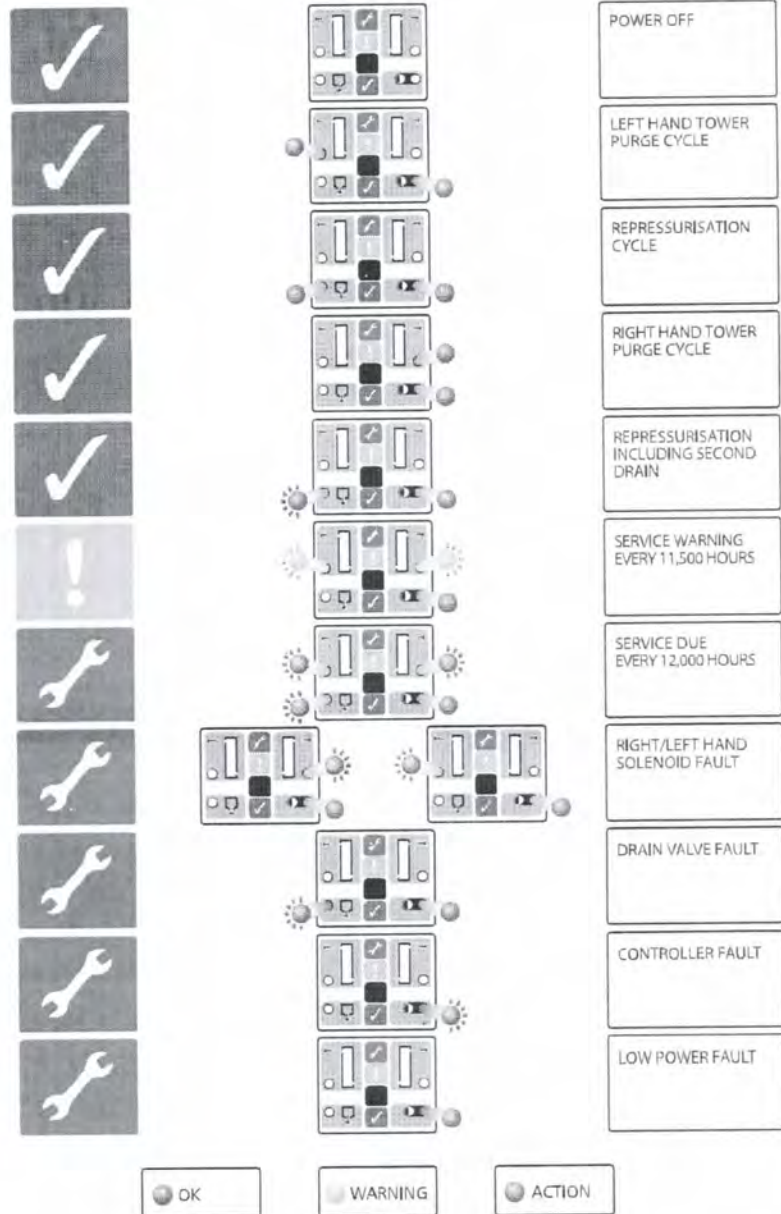

Figure 7.3. LED display panel

- (i) Power LED illuminates green and tower LED X illuminates green.
- (ii) After 120 seconds, tower LED X switches off and drain LED Z illuminates green.
- (iii) After a further 50 seconds drain LED Z switches off and tower LED Y illuminates green.
- (iv) After a further 120 seconds, tower LED Y switches off
- (v) After a further 50 seconds, tower LED X illuminates green - this is (i) in the cycle described above.
- (vi) The above cycle (i-iv) repeats.
- (vii) Run the dryer for a minimum of 6 hours to ensure dewpoint is adequate.
- (viii) Open valve B slowly.

11. Service and fault diagnosis



11.1 Service shutdown

1. Close valve B
2. Close valve A
3. Leave dryer running for 15 minutes to fully de-pressurise
4. Switch off all electrical power to the dryer

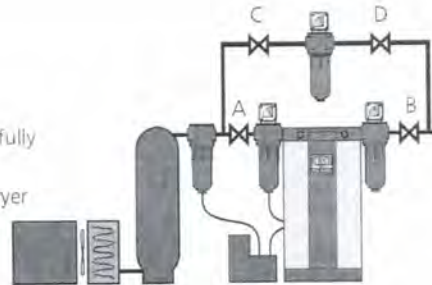

Under no circumstances must compressed air be allowed to flow through the dryer following switch off of electrical power. This will result in terminal failure of the desiccant cartridges and regeneration will not be possible.

11.2 Servicing and maintenance

1. Service intervals are every 12,000 operational hours. See chart below.
2. The shutdown procedure (above) must be carried out before a service is carried out.
3. The following kits are available.

Kit A: 12,000 hour service kit
Desiccant cartridges
Pre-filter element
Hex wrench
O-rings and seals
Re-set disc
Instruction leaflet

Kit B: 24,000 hour service kit contains
Desiccant cartridges
Pre-filter element
Hex wrench
O-rings and seals
Re-set disc
Exhaust valve diaphragms
Exhaust valve solenoids
Shuttle valves
Instruction leaflet

11.3 The service intervals and the kits required are detailed below.

2 years or 12,000 hours	Kit A
4 years or 24,000 hours	Kit B
6 years or 36,000 hours	Kit A
8 years or 48,000 hours	Kit B
10 years or 60,000 hours	Recommended service overhaul. Contact Walker Filtration.

11.4 Changing the desiccant cartridges

1. Follow the instructions as indicated below.

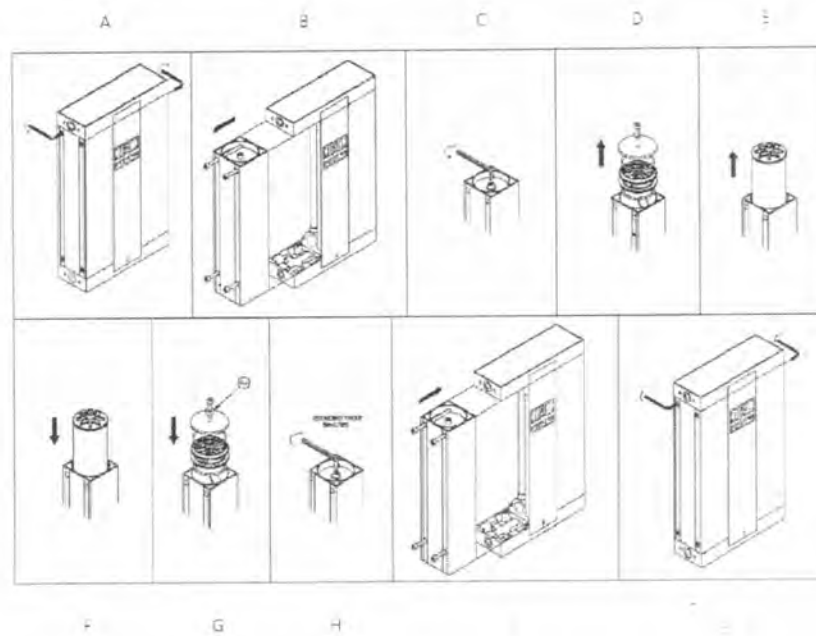

2. Ensure desiccant label is completed.
3. Repeat the procedure as shown in diagram on both towers.
Important: do not fully tighten retaining bolts until all towers have been serviced.
When complete tighten up all bolts to torque 5nm.
4. Dispose of desiccant cartridges in accordance with local waste regulations.
5. Follow the start-up procedure as detailed in section 10.

 11.5 Removing and replacing the front panel



1. Dryer with front fascia panel fitted.



4. Dryer with front fascia panel removed.



2. Remove single retaining screw.

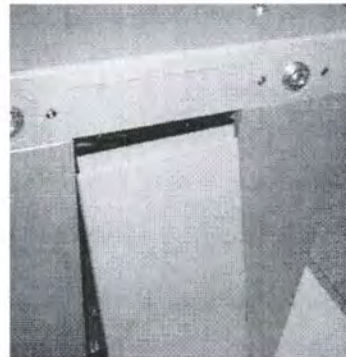

5. Re-fit front fascia panel by insertion of tongue into groove and pushing upwards and inwards.

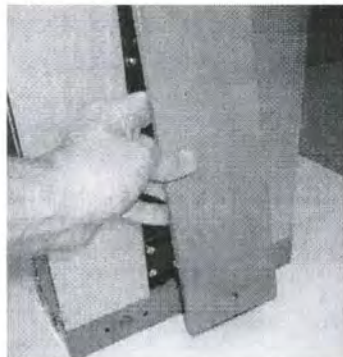

3. Remove front fascia panel by tilting outwards and downwards.



6. Replace single retaining screw.



11.6 Purge plug removal

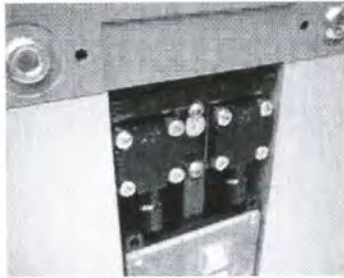

1. Remove front panel of dryer as described in 11.5 and locate purge plug in upper valve block.



4. Orifice in purge plug can be cleaned with warm soapy water. Do not use sharp implements or tools.

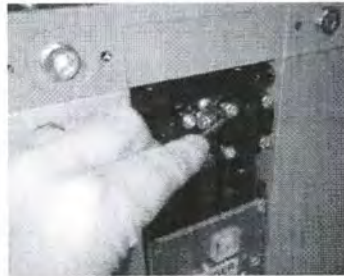

2. Remove purge plug fixing screw from upper valve block.



5. After thoroughly drying purge plug, push back into port in valve block. Ensure that 'o' rings are in place and in good condition.

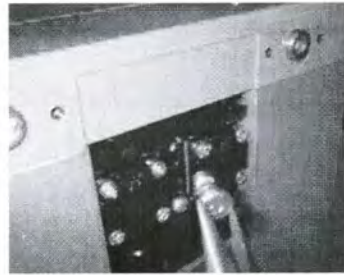

3. Remove purge plug from port in upper valve block, downwards.



6. Replace and tighten purge plug fixing screw in upper valve block.



11.7 Cleaning the silencer

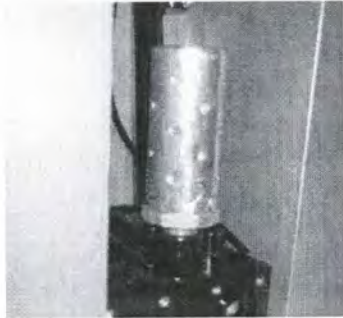

1. Silencer removal is best carried out during diaphragm replacement. See section 11.8.

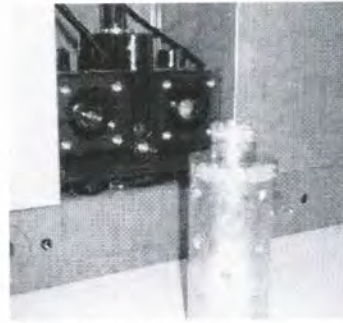

4. Clean threads on silencer.

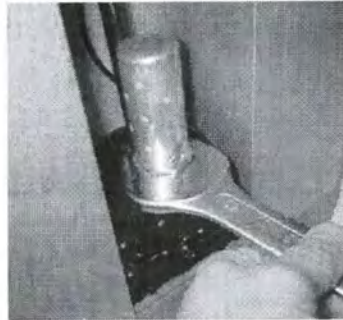

2. Disconnect silencer from valve block.

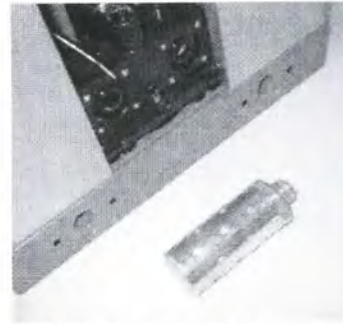

5. Silencer can be thoroughly cleaned in warm soapy water. Do not use sharp instruments or tools.



3. Remove silencer from dryer.

6. Ensure silencer is thoroughly clean and dry then replace by following the above procedure in reverse.



11.8 Diaphragm replacement



1. Remove front panel as described in section 11.5 and locate position of upper and lower bonnets.

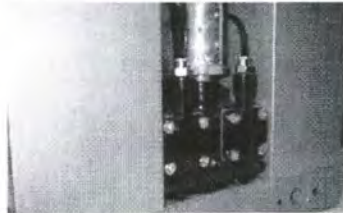

2. Lower bonnets.



3. Remove bonnets by means of four fixing screws.



4. Separate bonnet from valve block.



5. Disconnect tubing from fitting on bonnet.



6. Locate diaphragm assembly to be changed.



7. Remove diaphragm assembly.



8. Diaphragm and bonnet components.

9. Replace diaphragm and bonnet by following above procedure in reverse. Repeat above procedure for all diaphragms on dryer.

11.9 Resetting the controller

1. After following the start up procedure it is necessary to reset the controller. This is done by using the re-set disc (supplied with 12,000 hour service kit) then:
2. Hold the disc against the blue pad on the front display of the dryer panel for 5 seconds.
3. During the five second period the power indicator D will flash green. When the reset has been successful indicator B will flash red once to confirm that it has been completed successfully.

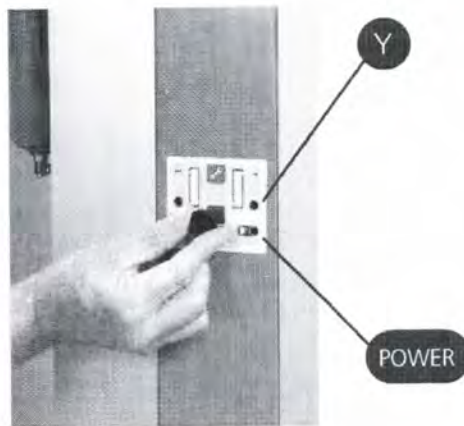

12. Dryer Troubleshooting

12.1 General troubleshooting



Before specific identification of any fault is looked for, the following general points must be verified:



- Has the unit been damaged externally or are any parts missing?
- Is power being supplied to the unit?
- Was startup carried out in accordance with the instructions in this manual?
- Are all external valves correctly set for operation?
- Do the operational conditions meet those specified at time of ordering and used for product selection?

The table below gives possible causes and corrective actions to faults that may occur on the dryer:

Problem	Possible cause	Action
Poor dewpoint	Liquid water at dryer inlet	Check pre-filtration and drains
	Excessive flow	Check actual flow against maximum specified
	Low inlet pressure	Check against specification
	High inlet temperature	Check against specification
	Silencer blocked or damaged	Replace silencer
Incorrect dryer operation	Air leaks	Tighten joints or fit new seals
	Jammed shuttle valves or faulted electrical components	See electrical operation trouble shooting section

Figure 9 1: General Troubleshooting Guide

12.2 Electrical troubleshooting (see display panel diagram in Section 11, page 26)

Problem	Possible cause	Display	Priority	Location	Action
No dryer function	No power supply	None			Check supply
Incorrect dryer operation	Left solenoid open or short circuit	Flashing red	P1	X LED	Replace solenoid valve
	Right solenoid open or short circuit	Flashing red	P1	Y LED	Replace solenoid valve
	Controller fault	Flashing red	P2	Power LED	Replace controller
	Lower power fault	Continuous red	P1	Power LED	Check supply
Drain not operating	Energy management active	None			Check installation
	Drain solenoid open or short circuit	Flashing red	P1	Z LED	Replace solenoid valve
	Controller fault	Flashing red	P2	Power LED	Replace controller

13. Dryer Sizing Table

Simplex dryer models are supplied with an A30XA pre-filter. Duplex models are supplied with an A55XA pre-filter.

DRYER MODEL	PIPE SIZE	INLET FLOW RATE		DRYER CONFIG	DIMENSION mm			WEIGHT		DIMENSION inch		
		Nm ³ /h	SCFM		A	B	C	Kg	lb	A	B	C
PD004SFD	3/8"	7	4	Simplex	445	281	92	13	29	17.5	11	3.6
PD006SFD	3/8"	10	6	Simplex	504	281	92	14	31	20	11	3.6
PD008SFD	3/8"	14	8	Simplex	565	281	92	15	33	22	11	3.6
PD010SFD	3/8"	17	10	Simplex	635	281	92	16.5	36	25	11	3.6
PD015SFD	3/8"	26	15	Simplex	815	281	92	19.5	43	32	11	3.6
PD025SFD	3/8"	38	22	Simplex	1065	281	92	24	53	42	11	3.6
PD035SFD	3/8"	56	33	Simplex	1460	281	92	31	68	57.5	11	3.6

Note: The temperature and pressure correction factors (below) should be applied to the above flow rates to suit the application and ensure dryer performance. All flow rates are based on 7.0 barg (100 psig) and 35°C (95°F) at the dryer inlet.

SPECIFICATION	
Standard pressure dewpoint	-40°C (-40°F) -70°C (-100°F) with application of flow correction factor
Min working pressure	4 barg (58 psig)
Max working pressure	16 barg (232 psig)
Electric controls	12VDC to 24VDC, 100VAC to 240VAC
Min inlet temperature	1.5°C (35°F)
Max inlet temperature	50°C (122°F)
Min ambient temperature	5°C (41°F)

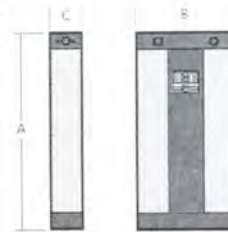

MODEL PD004SFD & PD035SFD

Operating pressure (barg (psig))	4 (58)	5 (72)	6 (87)	7 (100)	8 (116)	9 (130)	10 (145)	11 (160)	12 (174)	13 (189)	14 (203)	15 (218)	16 (232)
Pressure correction factor (PCF)*	0.62	0.75	0.87	1	1.12	1.25	1.37	1.5	1.62	1.75	1.87	2.0	2.12

*Always use the pressure correction factor (PCF) closest to the actual inlet pressure condition

Temperature (°C (°F))	20 (68)	25 (77)	30 (86)	35 (95)	40 (104)	45 (113)	50 (122)	Dewpoint (°C (°F))	-40 (-40)	-70 (-100)
Temperature correction factor (TCF)	1.07	1.06	1.04	1.00	0.93	0.78	0.64	Dewpoint correction factor (DCF)	1	0.7

13.1 Purge plug identification

The table below shows the purge plug fitted to all models across the range of operating pressures.

Dryer Model	Operating pressure (barg)												
	4	5	6	7	8	9	10	11	12	13	14	15	16
004	08	08	07	07	065	065	060	060	060	060	050	050	050
006	11	10	9	8	7.5	7.5	7.5	7	7	7	6.5	6.5	6.5
008	12	11	10	10	9	8	8	7.5	7.5	7.5	7	7	7
010	13	12	11	11	10	9	9	9	8.5	8.5	8.5	8	8
015	15	14	13	13	12	11	11	10	10	10	9	9	9
025	20	18	16	15	14	14	13	13	13	12	12	12	12
035	28	23	21	20	18	18	16	15	15	14	14	14	14

Each dryer is set with the appropriate purge plug for the operating pressure specified at point of order. The purge plug fitted on the unit will be identified on the purge plug label, located underneath the rating plate on the right. If the inlet pressure to the dryer is adjusted to operate at an alternative working pressure other than initially specified, please contact Walker Filtration and order an appropriate purge plug (identified in the table above). Before operating at the new working pressure this purge plug must be installed into the dryer. Failure to comply with these instructions could result in component fatigue and affect any warranty claims.

14. Environmental conditions

All dryers are designed to be safe under the following conditions:

- Indoor use
- Altitude up to 2000m
- Ambient temperature 5°C to 40°C
- Maximum RH 80% for temperatures up to 31°C, decreasing linearly to 50% RH at 40°C
- Mains supply voltage fluctuations not to exceed +/- 10% of nominal
- Transient over voltage IEC664 Class II
- Pollution degree 2, IEC 664

For operation extended from the above conditions, please contact Walker Filtration.

15. Warranties and liabilities

Claims for warranty and liability concerning personal injury or material damage are excluded if they resulted due to one or more of the following factors:

- Inappropriate use or application of the dryer.
- Technically incorrect installation, startup operation or maintenance of the dryer.
- Operation of a known damaged dryer.
- Failure to observe the information given in this manual concerning all life phases of the dryer.
- Undertaking constructional or operational modifications to the dryer without prior agreement with Walker Filtration.
- Inadequate monitoring and replacement of components of the dryer that are subject to wear or consumable.
- Improper completion of repairs.
- Use of non-original or non-approved parts for service or maintenance.

16. EC Declaration of Conformity

EC DECLARATION OF CONFORMITY
98/37/EC, 2006/95/EC, 2004/108/EC, 97/23/EC

Name of Manufacturer
Walker Filtration Ltd

Address of Manufacturer
Spire Road, Glover East, Washington, Tyne & Wear, NE37 3ES, England

Description of Product:
Compressed Air Dryer

Designation of Product:
Pro Dry 004SFD, Pro Dry 006SFD, Pro Dry 008SFD, Pro Dry 010SFD,
Pro Dry 015SFD, Pro Dry 025SFD, Pro Dry 035SFD

Standards Used:
ISO 12100-2:2003, BS EN 60204-1:2006, BS EN 61000-6-1:2007
BS EN 61000-6-2:2005, BS EN 61000-6-3:2007, BS EN 61000-6-4:2007,
ASME VIII Div. 1:1998

Notified Body (97/23/EC only):
Lloyd's Register EMEA - Notified Body No 0038
71 Fenchurch Street, London EC3M 4BS, England

Notified Body (Quality Systems): ISO9001:2000-LRQ0930553
Lloyd's Register EMEA - Notified Body No 0038
Hiramford, Middlemarch Office Village, Siskin Drive, Coventry, CV3 4FJ, England.

Conformity Assessment Module (97/23/EC only):
Pro Dry P004SFD to P025SFD - Module B
Pro Dry P035SFD - Module D1 - COV0310124/1

Name of Authorised Representative:
Andy Chalmers

Position of Authorised Representative:
Group Technical Manager

Declaration

I declare, on behalf of Walker Filtration Ltd and as the authorised representative, that the above stated product conforms to the requirements of the applicable New Approach Directives.



02/03/2009

WALKER FILTRATION

www.walkerfiltration.com

telephone: +44 (0)191 417 7816

fax: +44 (0)191 415 3748



Walker Filtration Ltd
Spire Road, Glovel East, Walsington,
Tyne & Wear,
NE17 5EJ, UK
Tel: +44 (0) 191 417 7816
Fax: +44 (0) 191 415 3748
email: uk2@walkerfiltration.co.uk
www.walkerfiltration.com

Walker Filtration PTY Ltd
3A Kja Court, Preston,
Victoria 3072,
Australia
Tel: +61 (0)3 9480 0950
Fax: +61 (0) 3 9493 1044
email: sales@walkerfiltration.com.au
www.walkerfiltration.com.au

Walker Filtration Inc
2320 West 50th Street,
Ft. St. John, PA 16506,
USA
Tel: +1 814 836 2900
Fax: +1 814 836 7921
email: usa@walkerfiltration.com
www.walkerfiltration.com

Walker Filtration SA (Pty) Ltd
Unit 5, New Park Estate,
Spring 2A 1955,
South Africa
Tel: +27 (0)11 813 1331
Fax: +27 (0) 11 813 1330
email: info@walkerfiltration.co.za
www.walkerfiltration.com

04-05-021 01 rev. 0

Walker Filtration Ltd. reserves the right to make changes and improvements to the product and / or this manual without prior notice.