

CONVEY-ALL™

OPERATOR'S MANUAL



TRANSFER CONVEYOR

1214-GN • 1615 • 1616-RC • 2218 • 2218-RC

**WARRANTY REGISTRATION FORM
and INSPECTION REPORT**

CONVEY-ALL™

Box 760, 275 Hespler Ave, Winkler, Manitoba R6W 4A8
T: (800) 418-9461 P: (204) 325-4195 F: (204) 325-8116
www.convey-all.com conveyors@convey-all.com

The Dealer must fill out this form, and be signed by both the Dealer and Buyer at the time of delivery. Scan or photograph the completed form (must be legible), and email it to: register@convey-all.com A copy of this form may also be mailed to the above address.

Buyer's Name _____	Dealer's Name _____
Address _____	Address _____
City _____	City _____
Province/State _____	Province/State _____
Postal Code/Zip Code _____	Postal Code/Zip Code _____
Country _____	Country _____
Phone Number _____	Phone Number _____
Unit's Model Number _____	Unit's Serial Number _____
Delivery Date _____	General Purpose: <input type="checkbox"/> Private <input type="checkbox"/> Commercial

UNIT INSPECTION

- All Fasteners Tight
- V-Belt(s) are Tensioned and Rotate Freely
- Driveline/Motor Mount Secured to Machine
- Fuel is turned off at Engine
- Machine and All Bearings Lubricated
- Conveyor Belt Aligned and Tensioned
- Tire Pressure Checked

SAFETY INSPECTION

- All Guards/Shields Installed and Secured
- All Safety Decals Clear and Legible
- Reflectors, Slow Moving Vehicle (SMV) Sign Clean
- Safety Chain on Hitch
- Reviewed Operating and Safety Instructions

I have thoroughly instructed the buyer on the above described equipment. The review included the content of the Operator's Manual, equipment care, adjustments, safe operation and warranty policy.

Date _____ Dealer's Signature _____

The above equipment and Operator's Manual have been received by me. I have been thoroughly instructed as to care, adjustments, safe operation and applicable warranty policy.

Date _____ Buyer's Signature _____

This page intentionally left blank

TABLE OF CONTENTS

DESCRIPTION	PAGE
Section 1: INTRODUCTION	1-1
1.1 Operator Orientation	1-1
1.2 Serial Number Location	1-1
Section 2: SAFETY.	2-1
2.1 Safety Orientation	2-2
2.2 General Safety	2-2
2.3 Equipment Safety Guidelines.	2-3
2.4 Safety Decals.	2-3
2.4.1 Applying Decals.	2-3
2.5 Safety Decal Location	2-4
2.6 Work Preparation	2-5
2.7 Lock-Out Tag-Out Safety.	2-5
2.8 Maintenance Safety	2-6
2.9 Tire Safety	2-6
2.10 Battery Safety	2-6
2.11 Engine Safety.	2-7
2.12 Operating Safety	2-8
2.13 Hydraulic Safety.	2-8
2.14 Electrical Safety	2-9
2.15 Transport Safety.	2-9
2.16 Storage Safety	2-9
Section 3: OPERATION	3-1
3.1 Machine Components	3-2
3.2 Components and Controls.	3-3
3.3 Machine Break-In.	3-7
3.4 Pre-Operation Checklist.	3-7
3.5 Attaching to Tow Vehicle	3-8
3.6 Conveyor Placement	3-9
3.7 Operating on Site.	3-10
3.7.1 Starting Conveyor	3-10
3.7.2 Stopping Conveyor	3-11
3.7.3 Emergency Stopping	3-11
3.7.4 Restarting after Emergency Stop.	3-11
3.7.5 Unplugging.	3-12
3.7.6 Hold Down Wheels on "GN" Models.	3-12

continued on next page

TABLE OF CONTENTS

DESCRIPTION	PAGE
3.8 Operating Hints	3-13
3.9 Transportation	3-14
3.10 Storage.....	3-15
Section 4: SERVICE AND MAINTENANCE	4-1
4.1 Fluids and Lubricants.....	4-1
4.1.1 Greasing.....	4-2
4.2 Servicing Intervals	4-3
4.2.1 Every 10 Hours or Daily	4-3
4.2.2 Every 50 Hours or Weekly	4-4
4.2.3 Every 100 Hours or Monthly	4-5
4.2.4 Every 200 Hours or Annually	4-6
4.3 Maintenance Procedures.....	4-7
4.3.1 Conveying Belt Tension	4-7
4.3.2 Conveyor Belt Alignment	4-8
4.3.3 Conveyor Belt Replacement	4-9
4.3.4 Drive Belt Tension	4-10
4.3.5 Check Pulley Alignment.....	4-11
4.3.6 Drive Belt Replacement	4-11
4.3.7 "GN" Hold Down Wheels Replacement.....	4-11
4.4 Service Record.....	4-13
4.5 Ordering Parts	4-14
Section 5: TROUBLESHOOTING.....	5-1
Section 6: REFERENCE.....	6-1
6.1 Specifications.....	6-1
6.2 Bolt Torque.....	6-2

Section 1: INTRODUCTION

Congratulations on your choice of a Convey-All™ Transfer Conveyor. It is designed to efficiently move grain, pulse crops or granular material between a truck, trailer, storage facility and another conveyor.

Convey-All™ is a member of the Meridian Manufacturing Inc. family. The equipment we design and manufacture meet the exacting standards of the agricultural industry.

Keep this manual handy for frequent reference and pass it on to new operators or owners. Call your dealer, distributor or Meridian Manufacturing Inc., if you need assistance, information, additional/replacement copies, or a digital copy of this document.

Information provided herein is of a descriptive nature. Meridian Manufacturing Inc. reserves the right to modify the machinery design and specifications provided herein without any preliminary notice.

Performance quality may depend on the material being handled, weather conditions and other factors.

1.1 OPERATOR ORIENTATION

The directions left, right, front and rear, as mentioned throughout this manual, are as seen from the tow vehicle driver's seat and facing the direction of travel. The hopper is the front of the conveyor.

1.2 SERIAL NUMBER LOCATION

Always give your dealer the serial number when ordering parts, requesting service or asking for other information. The conveyor's serial number is located at the hopper.

Use the space provided for easy reference:

Conveyor Model No: _____

Conveyor Serial No: _____

Engine Model No: _____

Engine Serial No: _____

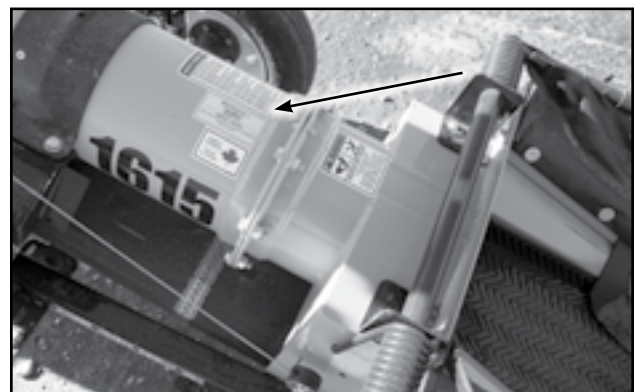

Fig 1 - Serial number location

This page intentionally left blank

Section 2: SAFETY

3 Big Reasons why safety is important to you:

- Accidents Disable and Kill
- Accidents Cost
- Accidents Can Be Avoided

The Safety Alert Symbol means:

The Safety Alert Symbol identifies important safety messages on the conveyor and in this manual.

The following signal words are used in this manual to express the degree of hazard for areas of personal safety.

When you see the symbol and/or the signal words described below, obey the accompanying message to avoid possible injury or death.

 **DANGER**

Indicates a hazardous situation that, if not avoided, will result in death or serious injury. This signal word is limited to the most extreme situations. Typically for machine components which, for functional purposes, cannot be guarded.

 **WARNING**

Indicates a hazardous situation, if not avoided, could result in death or serious injury. This word identifies hazards that are exposed when guards are removed. It may be used to alert against unsafe practices.

 **CAUTION**

Indicates a hazardous situation, if not avoided, could result in minor or moderate injury. It may be used to alert against unsafe practices.

NOTICE

Indicates practices or situations which may result in the malfunction of, or damage to equipment.

SAFETY INSTRUCTIONS

Safety instructions (or equivalent) signs indicate specific safety-related instructions or procedures.

2.1 SAFETY ORIENTATION

YOU are responsible for the SAFE operation and maintenance of your Convey-All™ Transfer Conveyor. Be sure that everyone who will operate, maintain or work around it, is familiar with the safety, operating and maintenance procedures.

This manual will take you step-by-step through your working day. It will alert you to all the safe practices that should be adhered to while operating the conveyor.

It has been said, "The best safety feature is an informed, careful operator." Good safety practices not only protect you but also the people around you. Make these practices a dynamic part of your workday.

Most accidents can be prevented. Do not risk injury or death by ignoring good safety practices.

- Conveyor owners must give operating instructions to operators or employees before allowing them to operate the machine.

Procedures must be reviewed annually thereafter, as per OSHA (Occupational Safety and Health Administration) regulation 1928.57.

- The most important safety device on this equipment is a SAFE operator. It is the operator's responsibility to understand all safety and operating instructions in this document, and to follow them.
- An untrained operator exposes himself and bystanders to possible serious injury or death.
- Think SAFETY! Work SAFELY!

2.2 GENERAL SAFETY

- Read and understand the Operator's Manual and all safety decals before operating, maintaining, adjusting or unplugging the conveyor. 

- Only trained, competent persons shall operate the conveyor. An untrained person is not qualified to operate the machine.

- Have a first-aid kit available for use should the need arise. 

- Provide a fire extinguisher for use in case of an accident. Store in a highly visible place. 

- Do not allow riders.

- Do not allow children, spectators or bystanders within hazard area around the machine.

- Wear appropriate protective gear. This list may include but is not limited to:

- Hard hat
- Protective shoes with slip resistant soles
- Eye protection
- Work gloves
- Hearing protection
- Respirator or filter mask
- Hi-Visibility safety vest



- Never use alcoholic beverages or drugs which can hinder alertness or coordination while operating this equipment.

Consult your doctor about operating this machine while taking prescription medications.

- If the elderly are assisting with farm work, their physical limitations need to be recognized and accommodated.

- Review safety related items annually with all personnel who will be operating or maintaining the conveyor.

2.3 EQUIPMENT SAFETY GUIDELINES

- Safety of the operator and bystanders is one of the main concerns in designing and developing this conveyor. However, every year many accidents occur which could have been avoided by a few seconds of thought and a more careful approach to handling equipment.
- Do not allow persons to operate this unit until they have been trained. They must know all safety precautions.

Review the safety instructions with all personnel annually.

- In order to provide a better view, some images in this manual may show an assembly with a safety guards removed.



Equipment should never be operated in this condition. Keep all guards in place. If removal becomes necessary for repairs, replace the guard prior to use.

- This equipment is dangerous to children and people unfamiliar with its operation.

The operator must be responsible, properly trained and physically able. You should be familiar with farm machinery in general.

- Never exceed the limits of a piece of machinery. If its ability to do a job, or to do so safely, is in question - DON'T TRY IT.
- Do not modify the equipment in any way. Unauthorized modification result in serious injury or death and may impair the function and life of the equipment.
- The design and configuration of this conveyor includes safety decals and equipment. They need to be clean, readable or in good condition.

2.4 SAFETY DECALS

- Keep safety decals clean/legible at all times.
- Replace safety decals that are missing or have become illegible.
- Replaced parts must display the same decal(s) as the original parts.
- All safety decals have a part number in the lower right hand corner. Use this part number when ordering replacements.
- Safety decals are available from your authorized distributor, dealer's parts department or from Meridian Manufacturing Inc.

2.4.1 Applying Decals:

1. Be sure the application area is clean and dry. Ensure the surrounding temperature is above 10°C (50°F).
 - a. Remove all dirt, grease, wax from surface.
 - b. Clean with a non-ammonia based cleaner.
 - c. Wipe the clean surface with isopropyl alcohol on paper towel, and allow to dry.
2. Determine the exact position before you remove the backing paper.
3. Peel a small portion of the split backing paper.
4. Align the decal over the specified area. Use a squeegee to carefully press the small portion, with the exposed adhesive backing, into place.
5. Slowly peel back the remaining paper and carefully smooth the rest of the decal into place.
6. Small air pockets can be pierced with a pin and smoothed out using the squeegee, or a piece of sign backing paper.

2.5 SAFETY DECAL LOCATION

The following illustrations show the general location of decals on this conveyor. The position of decals may vary depending on the machine's options. Decals are not shown at actual size.

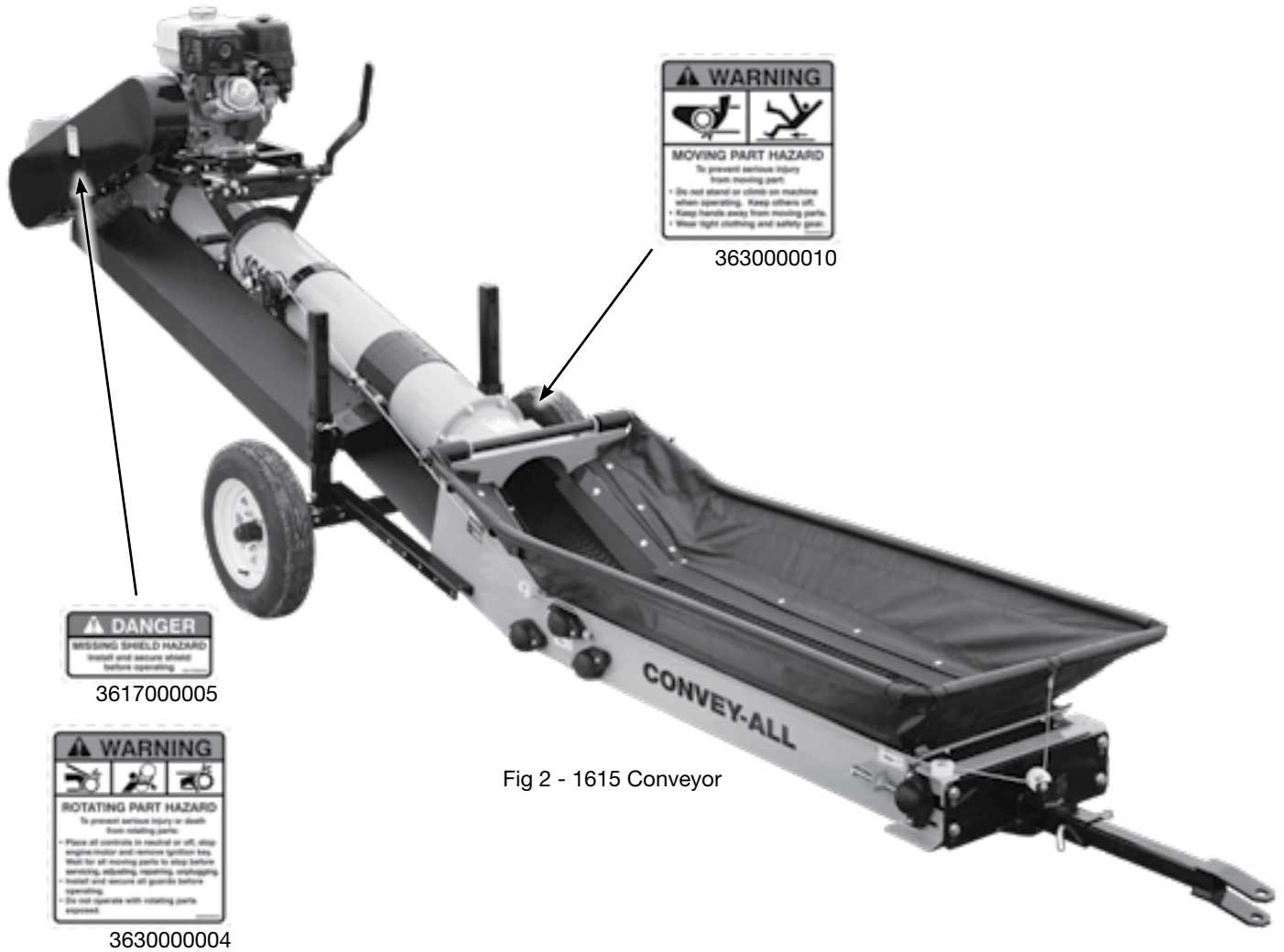

Fig 2 - 1615 Conveyor

REMEMBER - If safety decals have been damaged, removed, become illegible, or parts were replaced without signage, new ones must be applied. New decals are available from your authorized dealer.

2.6 WORK PREPARATION

- Never operate the conveyor and its engine until you have read this manual, and understand the information.

Also, read the engine operator's manual.

- Be familiar with the safety messages found on the decals around this unit.

- Personal protective equipment (PPE) include:

- Hard hat
- Eye protection
- Protective shoes
- Work gloves



They are recommended during installation, placement, operation, maintenance and removal of the equipment.

- Do not allow long hair, loose fitting clothing or jewelry to be around equipment.
- **PROLONGED EXPOSURE TO LOUD NOISE MAY CAUSE PERMANENT HEARING LOSS!**

Agricultural equipment can often be noisy enough to cause permanent, partial hearing loss. We recommend that you wear hearing protection on a full-time basis if the noise in the Operator's position exceeds 80 db.



Noise over 85 db on a long-term basis can cause severe hearing loss.

Noise over 90 db adjacent to the operator over a long-term basis may cause permanent, total hearing loss.

Note:

Hearing loss from loud noise (tractors, chain saws, radios, etc.) is cumulative over a lifetime without hope of natural recovery.

- Clear working area of stones, branches or hidden obstacles that might be hooked or snagged, causing injury or damage.
- Operate only in daylight or good artificial light.
- Be sure machine is in a stable position, is adjusted and in good operating condition.
- Ensure that all safety guards and safety decals are properly installed and in good condition.
- Before starting, inspect the unit for any loose bolts, worn parts, cracks, leaks or frayed belts. Make the necessary repairs.

Always follow the maintenance instructions.

2.7 LOCK-OUT TAG-OUT SAFETY

- Establish a formal Lock-Out Tag-Out program for your operation.
- Train all operators and service personnel before allowing them to work around the area.
- Provide tags on the machine and a sign-up sheet to record tag-out details.

2.8 MAINTENANCE SAFETY

- Review Section 4: Service and Maintenance, before maintaining or operating the conveyor.
- Follow good shop practices:
 - Keep service area clean and dry.
 - Be sure electrical outlets and tools are properly grounded.
 - Use adequate light for the job.
- Place all controls in neutral or off. Stop engine, and remove ignition key. Wait for all moving parts to stop before servicing, adjusting, repairing.
- Relieve pressure from hydraulic circuit before servicing.
- Before applying pressure to a hydraulic system, ensure all components are tight and that hoses and couplings are in good condition.
- Keep hands, feet, hair, and clothing away from all moving/rotating parts.
- Replace parts with genuine factory replacements parts to restore your equipment to original specifications.



Meridian Manufacturing Inc. will not be responsible for injuries or damages caused by using unapproved parts and/or accessories.

- Make sure there is plenty of ventilation. Never operate the engine in a closed building. The exhaust fumes may cause asphyxiation.
- Clear the area of bystanders, especially children, when carrying out any maintenance and repairs or making any adjustments.
- Place stands or blocks under the frame before working beneath the machine.
- Before resuming work, install and secure all guards when maintenance work is completed.
- Replace damaged or not clearly visible decals.

2.9 TIRE SAFETY

- Failure to follow procedure when mounting a tire on a wheel or rim can produce an explosion and may result in serious injury or death.
- Do not attempt to mount a tire unless you have proper equipment and training to do the job.
- Have a qualified tire dealer or repair service perform required tire maintenance.
- When replacing worn tires, make sure they meet original tire specifications. Never undersize.
- Reference the tire side wall for information on the maximum cold tire pressure (PSI). Keep the tires inflated to this setting.





2.10 BATTERY SAFETY

- Keep all sparks and flames away from battery, as the gas given off by electrolyte is explosive.
- Avoid contact with battery electrolyte. Wash off any spilled electrolyte immediately.
- Wear safety glasses when working near batteries.
- Do not tip batteries more than 45 degrees, to avoid electrolyte loss.
- To avoid injury from spark or short circuit, disconnect battery ground cable before servicing any part of electrical system.
- When storing conveyor for an extended period:
 - Remove the battery.
 - Be sure it is fully charged.
 - Store it inside.
 - Do not sit battery on a cold, concrete floor.
- Before using the battery, after it has been in storage, be sure it is charged.



2.11 ENGINE SAFETY

- Read and understand the operating manual provided with the engine. 
- Use proper tools to service engine.
- Do not run engine in an enclosed area. Exhaust gases contain carbon monoxide, an odorless and deadly poison.
- Store fuel in approved safety containers.
- Do not store fuel near open flame. 

Appliances such as a stove, furnace, or water heater use a pilot light which can create a spark. 
- No smoking when filling fuel tank.
- Do not remove fuel cap while engine is running.
- Do not refuel indoors where area is not well ventilated. Outdoor refueling is preferred.
- Do not refuel while engine is running. Allow engine to cool for 5 minutes before proceeding.
- Use fresh fuel. Stale fuel can gum carburetor and cause leakage.
- Check fuel lines and fittings frequently for cracks or leaks. Replace if necessary.
- Do not operate engine if fuel has spilled. Move machine away. Avoid creating any ignition until the fuel has evaporated.
- Do not run engine above rated speeds. This may result in damage and injury.
- Do not tamper with the engine speed selected by the original equipment manufacturer.
- Do not operate engine with grass, leaves, dirt or other combustible materials in muffler area.
- Do not operate engine without muffler.

- Do not tamper with governor springs, governor links or other parts which may increase the governed engine speed.
- Do not strike flywheel with hard object or metal tool. This may cause it to shatter in operation.
- Keep cylinder fins/governor parts free of grass and other debris which can affect engine speed.

WARNING

HOT EQUIPMENT HAZARD

Do not touch muffler, cylinder or fins while engine is running. Contact will cause burns.

- Do not use this engine on any forest covered, brush covered, or grass covered unimproved land, unless a spark arrester is installed on muffler. The arrester must be maintained in effective working order by operator.

In the State of California the above is required by law (Section 4442 of the California Public Resources Code). Other states may have similar laws. Federal laws apply on federal lands.

- Inspect the muffler periodically. Replace it when necessary.

If engine is equipped with a muffler deflector, inspect periodically. Replace with correct part.

- Do not check for spark, or crank engine with spark plug or spark plug wire removed.
- Do not run engine with air filter or its cover removed.

NOTICE

POSSIBLE ENGINE DAMAGE

Decelerate engine slowly to stop. Avoid choking the carburetor to stop engine. Choke only for an emergency stop.

2.12 OPERATING SAFETY

- Anyone who will be operating this conveyor, or working around it, must read this manual. They must know operating, maintenance, safety info.



Review the manual annually.

- Clean or replace all safety decals if they cannot be clearly read and understood.
- Place all controls in neutral, and stop the engine. Remove the ignition key. Wait for all moving parts to stop before adjusting, repairing or unplugging.
- Keep all bystanders, especially children, away from the machine when running.

Also, when authorized personnel are carrying out maintenance work.

- Establish a Lock-Out, Tag-Out policy for the work site. Be sure all personnel are trained in and follow all procedures.

Lock-out, tag-out all power sources before servicing the unit or working around equipment.

- Be familiar with machine hazard area. If anyone enters hazard areas, shut down machine immediately. Clear the area before restarting.

- Keep hands, feet, hair and clothing away from all moving/rotating parts.



- Do not allow riders on the conveyor when moving or transporting it.

- Keep working area clean and free of debris to prevent slipping/tripping.



- Do not operate the conveyor when any guards are removed.

2.13 HYDRAULIC SAFETY

- Always place hydraulic controls in neutral. Then relieve pressure in hydraulic system before maintaining or working on machine.
- Be sure that all components in the hydraulic system are kept in good condition and are clean.
- Replace any worn, cut, abraded, flattened or crimped hoses.
- Do not attempt any makeshift repairs to the hydraulic fittings or hoses by using tape, clamps or cements. The hydraulic system operates under extremely high-pressure. Such repairs will fail suddenly and create a hazardous and unsafe condition.

- Wear proper hand and eye protection when searching for a high-pressure hydraulic leak. Use a piece of wood or cardboard as backstop instead of hand to isolate/identify a leak.



- If injured by a concentrated high-pressure stream of hydraulic fluid, seek medical attention immediately. Serious infection or toxic reaction can develop from hydraulic fluid piercing the skin surface.



2.14 ELECTRICAL SAFETY

- Have only a qualified electrician supply power. All wiring should comply with the ANSI/NFPA 70 electrical requirements.



For North America make certain that sufficient amperage, at proper voltage and appropriate frequency for your geographical area is available before connecting power. All wiring should comply with ANSI/NFPA 70 electrical requirements. Have a licensed electrician provide power to the machine.

- Make certain that the conveyor motor is properly grounded at the power source.
- Make certain that all electrical switches are in the OFF position before plugging in the conveyor.
- Turn machine OFF, shut down and lock out power supply (safety lock-out devices are available through your Convey-All dealer parts department) and wait for all moving parts to stop before assembling, servicing, adjusting, maintaining or repairing.
- Disconnect power before resetting any motor.
- Replace any damaged electrical plugs, cords, switches and components immediately.
- Do not work on the conveyor's electrical system unless the power cord is unplugged or the power supply is locked out.

2.15 TRANSPORT SAFETY

- If transporting on a trailer, be sure that it is equipped with brakes that are in good working order. Be familiar with their operation.

- Check that all the lights, reflectors and other lighting requirements are installed and in good working condition.



- Never allow riders on the conveyor.
- Comply with all local laws governing safety and transporting of equipment on public roads.
- Do not exceed a safe travel speed. Slow down for rough terrain and when cornering.
- Plan your route to avoid heavy traffic.
- Do not drink and drive.
- Be a safe and courteous driver. Always yield to oncoming traffic in all situations, including narrow bridges, intersections, etc. Watch for traffic when operating near or crossing roadways.

2.16 STORAGE SAFETY

- Store in an area away from human activity.
- If required, make sure the unit is solidly blocked up.
- Remove the battery and store in a dry location. Do not sit it on a cold concrete floor.
- Make certain all mechanical locks are safely and positively connected before storing.
- Do not permit children to play on or around the stored machine.

This page intentionally left blank

Section 3: OPERATION

WARNING

- Read and understand the Operator's Manual, and all safety decals, before using.
- Stop the engine. Place all controls in neutral, remove ignition key and wait for all moving parts to stop before servicing, adjusting, or repairing or unplugging.
- Clear the area of bystanders, especially children, before starting.
- Keep working area clean and free of debris to prevent slipping or tripping.
- Keep hands, feet, hair and clothing away from all moving and/or rotating parts.
- Do not allow riders on the conveyor when driving mover kit.
- Do not operate conveyor with guards removed.
- Chock wheels of conveyor before starting.
- Be familiar with machine hazard area. If anyone enters hazard areas, shut down machine immediately. Clear area before restarting.
- Establish a lock-out, tag-out policy for the work site. Be sure all personnel are trained in and follow all procedures. Lock-out tag-out all power sources before servicing the unit.

The Convey-All™ Transfer conveyor is designed to efficiently move grain, pulse crops, or granular material from under a truck, railcar or storage facility to another conveyor. Power is provided by a gas engine, electric or hydraulic motor.

It is the responsibility of the owner and operators to read this manual and to train all personnel before they start working with the machine. Follow all safety instructions exactly - it is everyone's business. By following recommended procedure, a safe working environment is provided for the operator, co-workers and bystanders in the area around the work site.

The design and configuration of this conveyor includes safety decals and equipment. Hazard controls and accident prevention are dependent upon the personnel operating and maintaining it. Their awareness, concern, prudence and proper training are crucial.

Many features incorporated into this machine are the result of suggestions made by customers like you.

By following the operating instructions, in conjunction with a good maintenance program, your Truck Load conveyor will provide many years of trouble free service.

3.1 MACHINE COMPONENTS

The Transfer Conveyor is portable and low enough to fit under trucks or low storage facilities. The "RC" models have an extra low profile to fit under rail cars.

Normally, the discharge is directed into another conveying system.

A gas engine, electric or hydraulic motor can supply power to the drive located at the discharge end.

A manual winch is used to raise and lower the hopper frame.

The main components, and their general location are listed below:

- a. Conveyor Tube
- b. Hopper
- c. Hopper Winch
- d. Discharge Hood
- e. Engine/Motor Mount (gas engine shown)
- f. Drive Belts or Hydraulic Motor
- g. Axle and Wheels
- h. Hitch
- i. Document Holder

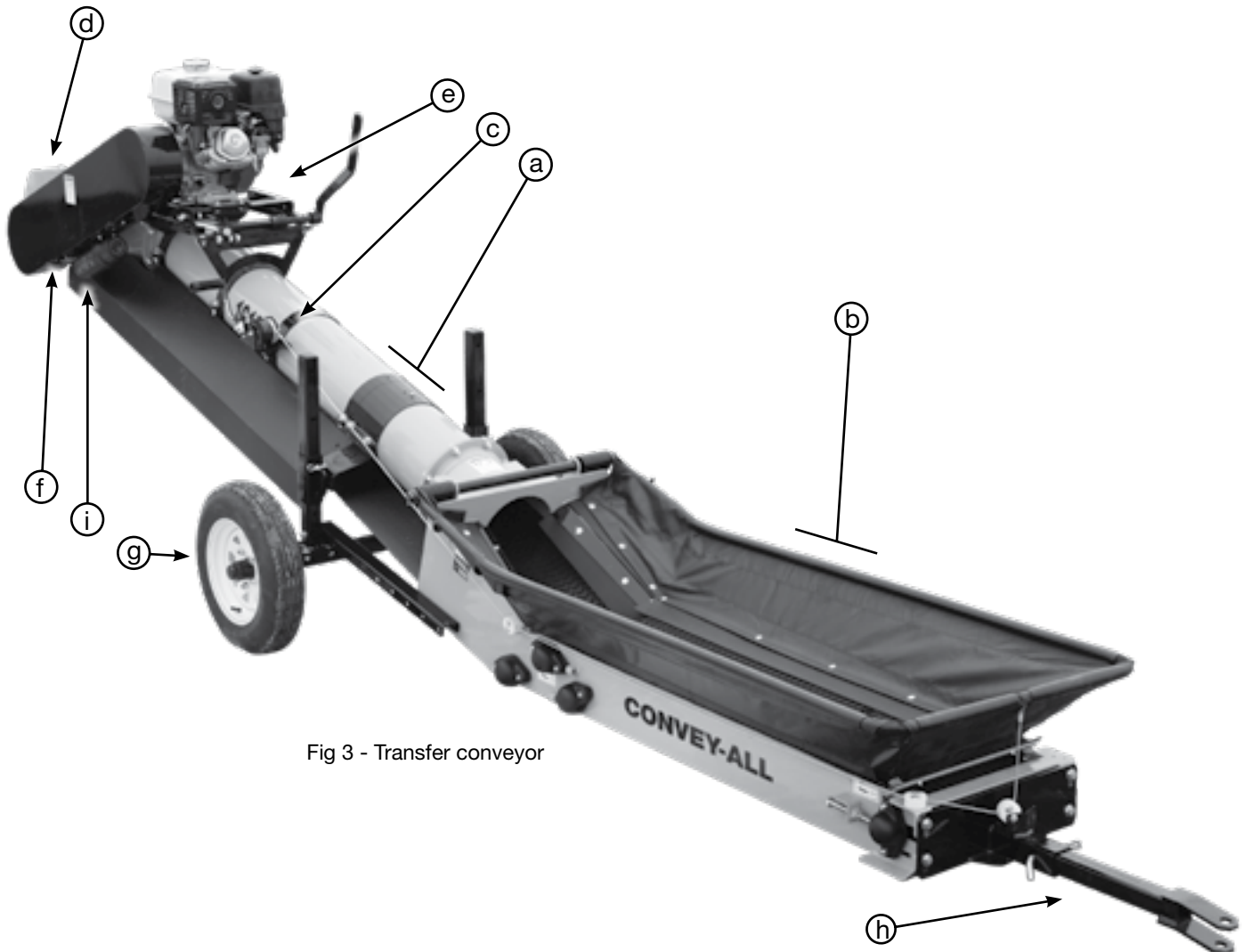

Fig 3 - Transfer conveyor

3.2 COMPONENTS AND CONTROLS

Before starting to work, all operators should familiarize themselves with the location and function of the components and controls on your specific unit.

Options and location may vary depending on model.

Gas Engine:

Read the engine manufacturer's manual for more detailed instructions.

- a. Ignition Switch:
This switch controls the power to the engine electrical system. Turn clockwise to start, vertical position is ON. Turn the key counterclockwise to turn OFF.
- b. Circuit Protector:
This protector monitors the engine electrical circuit. Its LED will illuminate when the circuit exceeds its preset value and trip the breaker. Depress indicator to reset the breaker and the light will go out.
- c. Engine Mount Lever:
This lever sets the position of the engine mount.

Move the lever to slide the engine base away from the drive pulley, disengaging the belt.

IMPORTANT:

Always disengage drive belt before starting or stopping engine.

Move the lever again, to engage drive belt. Set the belt tension so the belt does not slip during operation.

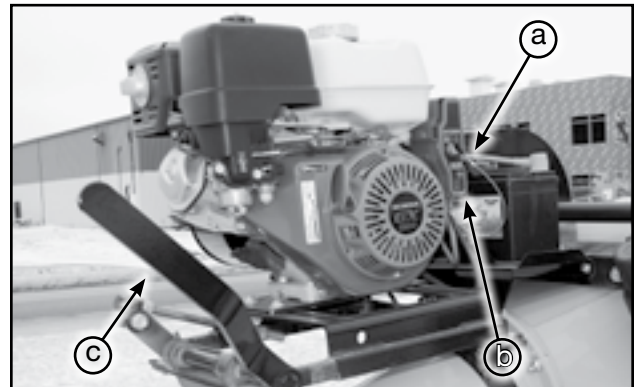

Fig 4 - Gas engine with electric start

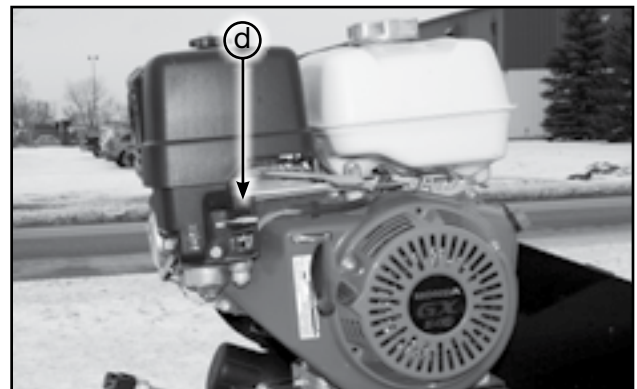

Fig 5 - Gas engine

- d. Choke:
This lever controls the position of the choke. Slide the lever to the left to close the choke valve for starting when the engine is cold. Slide to the right to open the choke as the engine warms.

Always open the choke fully when operating the machine.

- e. Throttle:
This lever controls the engine RPM. Move the lever left to increase the engine speed and right to decrease.

Always run at maximum engine RPM when operating.

- f. Fuel Shut-Off Switch:
This switch controls the flow of fuel to the engine. Move the switch to the right to open the valve and start the flow of fuel. Move the switch left to close the valve and the engine will run.

- g. Starting Rope:
This retracting rope and T-bar is used to turn the engine over for starting. Grasp the T-bar firmly and pull the rope sharply to start the engine. Close the choke if the engine is cold.

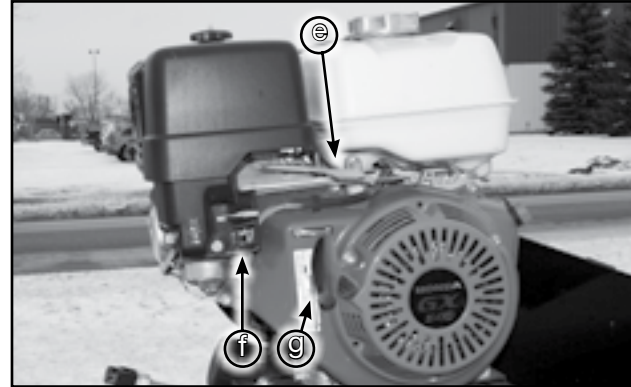

Fig 6 - Gas engine



Fig 7 - Electric motor



Fig 8 - Hydraulic motor, hoses not attached

Electric Motor:

All conveyors with electric power option rely on the dealer and customer to select the motor with the appropriate horsepower and to hire a licensed electrician to provide power, as per the National Electrical Code ANSI/ NFPA 70 and local codes.

A variety of switches can be used. Install an ON/OFF switch next to the motor for the convenience of the operator.

Minimum Power Requirements:

MODEL	ELECTRIC HP
1214-GN	5hp
1615	7.5hp
1616-RC	7.5hp
2218	10hp
2218-RC	10hp

Table 1 - Power Requirements

Hydraulic Motor:

Position the power unit next to the conveyor, and connect hydraulic hoses to the couplers.

Chevron Belt with Alligator® Lacing:

Convey-All™ conveyors use a 2 ply, 220 weight, chevron belt with Alligator® Lacing.

⚠ WARNING

MOVING BELT HAZARD

Never climb into hopper onto the belt.
The belt may inadvertently be turned on.

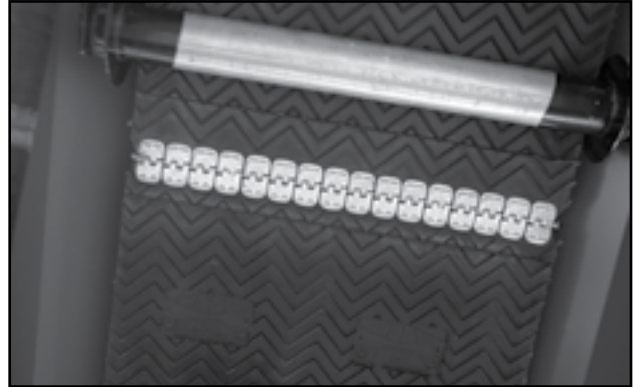

Fig 9 - Chevron belt with Alligator® lacing

Hopper Frame:

The hopper is designed with a spring loaded frame. It can be raised or lowered with a winch. When the hopper sides are raised, the maximum conveying capacity is obtained.

⚠ WARNING

UNEXPECTED MOVEMENT

Do not release Hopper Winch handle when ratchet lever is in unlocked position, with load on winch.
Handle could spin violently causing injury.



Fig 10 - S-Neck hopper

Railcar Hopper (Optional):

This hopper has a very low profile to allow for positioning under a railcar hopper.



Fig 11 - Railcar hopper

UBH Hopper (Optional):

This hopper contains large hold-down wheels at the transition between the hopper and tube.

This unit is generally used for gravel or other aggregate.



Fig 12 - UBH hopper

Goose Neck (GN) Hopper (Optional):

This hopper contains hold-down wheels inside the transition housing between the hopper and tube.

⚠ WARNING**UNEXPECTED MOVEMENT**

Do not release Hopper Winch handle when ratchet lever is in unlocked position, with load on winch.

Handle could spin violently causing injury.

Hopper Winch:

Use the winch to raise and lower the hopper frame or the railcar hopper side panels.

Frame Height/Angle:

The unit is designed with an adjustable wheel frame that can be used to set the frame angle or discharge height.

Set at the height appropriate for your application. Keep the angle as low as possible to insure that the conveying capacity is at the maximum.

To change the balance of the machine for moving around the yard; loosen the clamp around the tube. Slide or tap the undercarriage to adjust its position along the tube. Tighten the clamp again.

Discharge Hood:

The Discharge Hood is designed with brackets that allow it to tilt or be removed. This will facilitate throwing material at a different angles from the end of the machine. Set the hood appropriately for the application.



Fig 13 - Goose neck hopper



Fig 14 - Railcar winch



Fig 15 - Frame adjustment

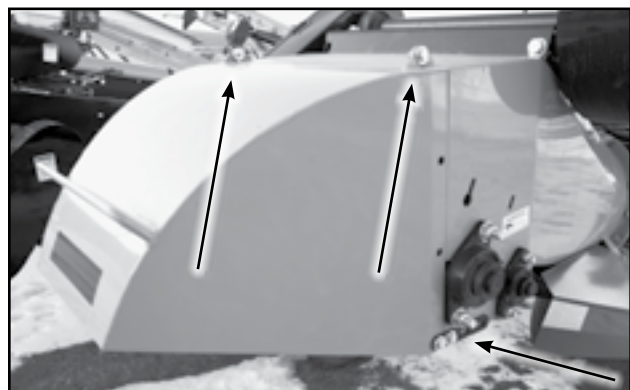

Fig 16 - Discharge hood adjustments

3.3 MACHINE BREAK-IN

There is no operational restrictions on the conveyor when used for the first time.

The conveyor belt alignment is set at the factory, to track correctly without carrying a load.

Before Starting Work:

1. Read conveyor and engine operator manuals.
2. Run the unit for half an hour to seat the conveyor belt and hopper flashing. It is normal for rubber from the flashing to be expelled out the discharge and form a pattern on the belt.

After Operating or Transporting for 1/2 hour:

3. Re-torque all the wheel bolts.
4. Check fuel and engine oil levels.
5. During the conveyors first few minutes of operation, check belt tension and alignment to ensure the factory preset does not vary under loaded conditions.
6. Check the flashing seal on the hopper. If any product comes out of the hopper around the flashing; stop the belt, loosen flashing mounting screws and adjust. Retighten anchor screws and try again. Repeat until no product is lost.
7. Check the condition of all hydraulic lines, hoses and connections. Repair or replace any damaged system components.
8. Check that all guards are installed and function as intended.

After Operating For 5 Hours and 10 Hours:

Repeat steps 1 through 8 above.

Service and maintain the conveyor as defined in Section 4: Service and Maintenance.

3.4 PRE-OPERATION CHECKLIST

Efficient and safe operation of the conveyor requires that each operator knows the operating procedures.

It is important for both the personal safety and maintaining the good mechanical condition of the machine that this checklist is followed.

Before operating the conveyor, and each time thereafter, the following areas should be checked.

1. Check worksite. Clean up working area to prevent slipping or tripping.
2. Be sure that the battery is fully charged. If needed, charge the battery before connecting it with the battery cables.
3. Lubricate and service the machine as per the schedule outlined in the Section 4.2.
4. Check that all guards are installed, secured and functioning as intended. Do not operate with missing or damaged shields.
5. Check that the belt is properly tensioned and aligned. Ensure it is not frayed or damaged. Refer to Section 4.3.1 and 4.3.2
6. Be sure conveyor wheels are chocked.
7. Check that discharge and intake hopper areas are free of obstructions.

NOTICE

UPENDING HAZARD

Anchor or support conveyor during operation. When lower half empties of material, the weight balance transfers to the discharge end of the machine, which can cause upending.

3.5 ATTACHING TO TOW VEHICLE

The Transfer Conveyor may be attached to a truck or tractor whenever it is moved. It is road worthy and may be transported by a truck over long distances.

1. Make sure that bystanders, especially small children, are clear of the working area.
2. The hitch is removable. Install hitch and secure with the anchor pin and retainer before using hitch.
3. Back up to the conveyor.
 - Set the park brake before dismounting.
4. Remove the chocks from the wheels.
5. Lift the hopper to the drawbar of the towing vehicle and install the pin with its retainer.
6. Secure the safety chain around the drawbar cage to prevent unexpected separation.
7. The conveyor is ready for transport.

Reverse the above procedures to unhooking.

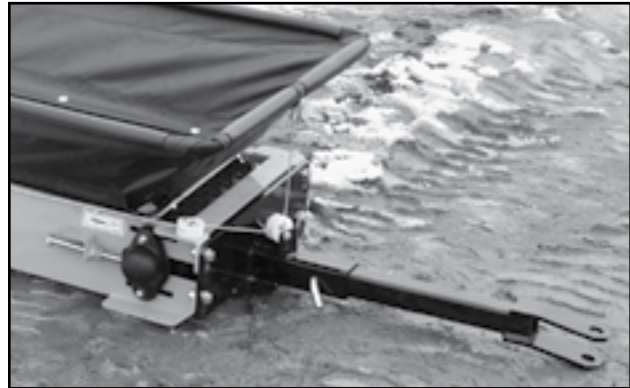

Fig 17 - Hitch

3.6 CONVEYOR PLACEMENT

Follow this procedure when placing the Transfer Conveyor into working position:

1. Clear the area of bystanders, especially small children, before starting.
2. Be sure there is enough clearance from other equipment to move the machine into position.
3. Move the machine under the grain truck or to the secondary conveyor and storage facility.

Note:

The machine is evenly balanced.
Push down slightly on discharge end
to raise hopper off the ground
and maneuver easily.

4. Place chocks in the front and rear of each wheel.
5. Position the next conveyor or conveying system under the discharge hood and secure.
6. For the Electric Motor Unit:
 - Have a certified electrician provide power to the machine.
 - Provide convenient shutdown switches and comply with local electrical codes.
 - Use a totally enclosed electric motor. Be sure electric motor is properly grounded.
7. For the Hydraulic Drive Unit:
 - Position the power unit next to the conveyor.
 - Chocks the front and rear wheels of the power unit.
 - Connect hydraulic hoses to the couplers.



Fig 18 - Conveyor under truck



Fig 19 - Hopper sides raised



Fig 20 - Wheels chocked

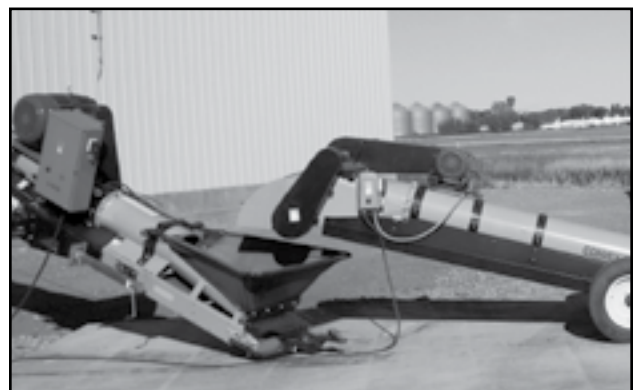

Fig 21 - Next conveyor

3.7 OPERATING ON SITE**3.7.1 Starting Conveyor:****Gas Engine Units:**

1. Move engine assembly to its loosest drive belt tension.
2. Turn ignition switch on.
3. Move throttle to its 1/4 position for starting.
4. Close choke if engine is cold.
5. Pull sharply on the starting rope until the engine starts.
6. Run until the engine warms and the choke is opened.
7. Move engine assembly to engage drive belt.
8. Increase engine speed to full throttle.
9. Start flow of material.

Electric Motor Units:

1. Turn the electric motor ON.
2. Start the flow of material and unload.

Hydraulic Drive Units:

1. Place all controls in neutral.
2. Start tractor engine and run at low idle.
3. Place hydraulic lever in detent.
4. Increase engine speed to rated RPM.
5. Begin unloading into the hopper.



Fig 23 - Gas engine



Fig 22 - Electric motor



Fig 24 - Hydraulic motor

3.7.2 Stopping Conveyor:

Gas Engine Units:

1. Run until conveyor belt is empty.
2. Reduce speed to low idle.
3. Move engine assembly to disengage drive belt.
4. Shut off engine

Electric Motor Units:

1. Run until the conveying belt is empty.
2. Turn off motor and lock out power source.

Hydraulic Drive Units:

1. Run until conveying belt is empty.
2. Reduce engine speed to low idle.
3. Place hydraulic lever in neutral.
4. Shut off engine.

3.7.3 Emergency Stopping:

Although it is recommended that the conveyor belt be emptied before stopping, in an emergency situation, stop or shut-down the power source immediately.

Correct the emergency before resuming work.

3.7.4 Restarting after Emergency Stop:

When the conveyor is shut down inadvertently or in an emergency, the conveyor belt will still be covered with product.

Remove as much product from the hopper as possible, before restating the engine.

Since start-up torque loads are much higher than normal when belt is full, restart at a low engine speed. The engine speed can be increased to full throttle, when the belt is empty.

Now, product can again be unloaded into the conveyor hopper.



Fig 25 - Working conveyor

3.7.5 Unplugging:

In unusual moisture, crop or material conditions, the machine can plug. When unplugging, follow this procedure:

1. Place all controls in neutral or off, stop engine or motors and disable power source.
2. Remove the material from the discharge and the intake area.
3. Reposition unit if discharge area plugs due to lack of clearance.
4. Restart unit.

3.7.6 Hold Down Wheels on "GN" Models:

In situations where the conveying belt jams or is overtightened, the belt can come out from under the hold down wheels at the transition point. To correct situation:

1. Run until machine is empty or remove all material from machine.
2. Turn engine or motor off and disable the power source.
3. Move conveyor belt into its loosest position. Refer to Section 4.3.1
4. Remove transition cover.
5. Push conveyor belt under hold down wheels.
6. Set tension and alignment. Refer to Section 4.3.1
7. Install and secure transition cover.

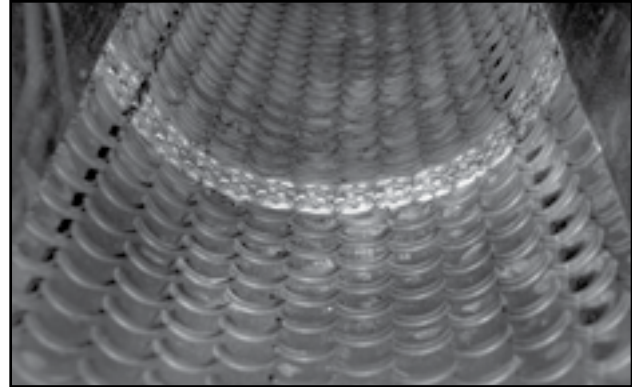

Fig 26 - Conveyor lacing

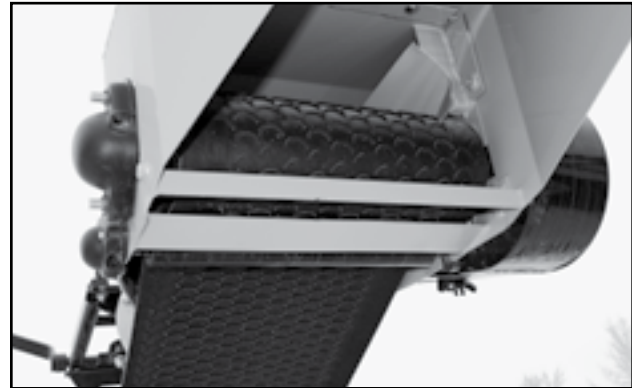

Fig 27 - Under discharge hood

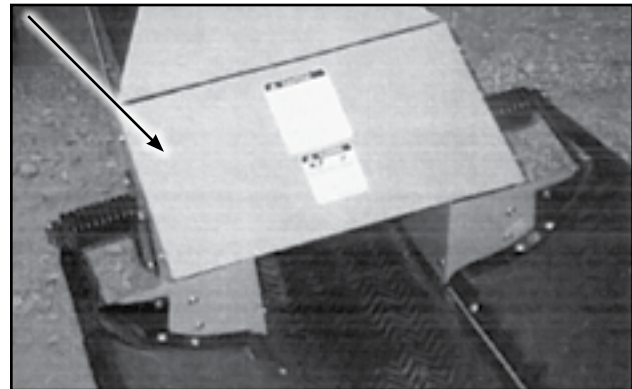

Fig 28 - Transition cover



Fig 29 - Hold down wheel location

3.8 OPERATING HINTS

- Keep the hopper full for maximum capacity. Most efficient results will be obtained when flow of incoming product is directed at the top of the hopper (closer to the tube).
- Always listen for any unusual sounds or noises. If any are heard, stop the machine and determine the source. Correct the problem before resuming work.
- The machine is available in 10" and 14" diameter tubes, as well as 16" and 22" belts. The larger the tube and wider the belt, the higher the capacity will be.
- Never allow anyone into the workplace hazard area. If anyone enters, stop immediately. The visitor must leave before resuming work.
- Position discharge hood appropriately for the application. Refer to page 3-6

- **Belt Speed:**
The best results are obtained when the input drives are set to provide a belt speed of 400 to 500 ft/min.

Count the number of belt revolutions per unit time to determine belt speed. Use the lacing as a reference when counting belt revolutions.

Contact your dealer or the factory for the appropriate drive components to give the recommended belt speed.

- Do not run the machine for long periods of time with no material on the belting. This increases the wear. Try to run only when moving material.
- Keep the hopper full for maximum capacity.
- Most efficient results will be obtained when flow of incoming material is directed to the front of the hopper (closer to the tube).

- **Belt Tension:**
There may be a rapid decrease in belt tension during the first few hours of operation until the belt has worn in.

The correct operating tension is the lowest tension at which the belt will not slip under peak load conditions.

- The hopper is designed with flashing to seal the junction of the belt with the sides of the hopper. It must be kept in good condition to prevent the material from "leaking" out of the hopper. Replace flashing if "leakage" occurs.



Fig 30 - Feeding the hopper

3.9 TRANSPORTATION

Convey-All™ Transfer Conveyors are designed to be easily and conveniently moved from place to place.

When transporting, follow this procedure:

1. Review the Transport Safety Schematic before starting.
2. Be sure all bystanders are clear of the machine.
3. Electric Motor Units:
Unplug the power cord, wrap it around frame and secure to prevent dragging.

Hydraulic powered units:

Disconnect hydraulic hoses, remove power source, wrap hose around frame and secure to prevent dragging.

4. The unit is highway safe. It can also be placed on a transport vehicle or trailer and tied down securely.
5. Hitch is removable. Place hitch, then attach it to a tractor or truck using a hitch pin with a retainer and a safety chain.
6. Remove chocks from the wheels.
7. Slowly pull away from the working area.
8. Ensure the SMV (Slow Moving Vehicle) emblem and all the lights and reflectors that are required by the local highway and transport authorities are in place, are clean and can be seen clearly by all overtaking and oncoming traffic.

9. Keep to the right and yield the right-of-way to allow faster traffic to pass. Drive on the road shoulder, if permitted by law.
10. Do not allow riders on the machine or tractor.
11. During periods of limited visibility, use pilot vehicles or add extra lights to the machine.
12. Always use hazard flashers on the tractor when transporting unless prohibited by law.



Fig 31 - Chocked wheels

3.10 STORAGE

After the season's use, the conveyor should be thoroughly inspected and prepared for storage.

Repair or replace any worn/damaged components to prevent unnecessary down time next season.

For a long, trouble free life, this procedure should be followed when preparing the unit for storage:

1. Remove all residual material from hopper and tube.
2. Inspect all moving or rotating parts to see if anything has become entangled in them. Remove the entangled material.
3. Thoroughly wash the conveyor to remove all dirt, mud, debris and residue.
 - Clean inside the conveyor tube.
 - Wash the top and under the conveyor belt.
4. Lubricate all grease fittings and bearings.
 - Ensure all grease cavities have been filled with grease to remove any water residue from the washing. This also protects the bearing seals.
5. For hydraulic drive units:
 - Apply a light coat of oil to the roller chain coupler to prevent rusting.
 - Inspect all hydraulic hoses, fittings, lines, couplers and fittings. Tighten any loose fittings. Replace any hose that is badly cut, nicked or abraded or is separating from the crimped end of the fitting.
6. Touch up all paint nicks and scratches to prevent rusting.
7. For gas engine with electric start:
 - Remove the battery, be sure it is fully charged.
 - Store it inside.
 - Do not sit the battery on a cold floor.
8. Select a storage area that is dry, level and free of debris.
 - If it cannot be placed inside, cover the gas engine or electric motor with a water proof tarpaulin and tie securely in place.
9. Store away from human activity.
10. Do not allow children to play on or around the stored machine.



Fig 32 - Railcar hopper transfer conveyor

This page intentionally left blank

Section 4: SERVICE AND MAINTENANCE

WARNING

- Review the Operator's Manual and all safety items before maintaining the conveyor.
- Clear the area of bystanders, especially children, before repairing or adjusting.
- Before servicing, repairing or unplugging; place controls in neutral, stop engine, remove ignition key and wait for moving parts to stop.
- Follow good shop practices:
 - Keep service area clean and dry.
 - Be sure electrical outlets and tools are properly grounded.
 - Use adequate light for the job at hand.
- Relieve pressure from the hydraulic circuit before servicing.
- Before applying pressure to a hydraulic system, make sure all components are tight, hoses and couplings are in good condition.
- Keep hands, feet, hair and clothing away from all moving and/or rotating parts.
- Make sure there is plenty of ventilation. Never operate the engine in a closed building. The exhaust fumes may cause asphyxiation.
- Place stands or blocks under frame before working beneath the unit.
- When maintenance is complete, before resuming work, install and secure all guards.
- Keep decals clean, replace if not readable.

By following the operating instructions, in conjunction with a good maintenance program, your conveyor will provide many years of trouble free service.

4.1 FLUIDS AND LUBRICANTS

Fuel and Engine Oil:

Refer to the engine's operator manual for specific service and maintenance information.

Grease:

Use an SAE multipurpose high temperature grease with extreme pressure (EP) performance. Also acceptable, SAE multipurpose lithium based grease.

Storing Lubricants:

Your machine can operate at top efficiency only if clean lubricants are used. Use clean containers to handle all lubricants. Store them in an area protected from dust, moisture and other contaminants.

4.1.1 Greasing:**NOTICE****GREASING HAZARD**

Too much grease causes excessive overheating. Under-greasing accelerates equipment wear.

No grease should be seen around bearings. If there is, too much grease was applied and the seal has ruptured!

IMPORTANT:

Grease bearings only one pump per month under normal usage conditions.

Bearing greasing frequency should be determined by usage and conditions.

1. Use a hand-held grease gun for all greasing.
2. Wipe grease fitting with a clean cloth before greasing, to avoid injecting dirt and grit.
3. All bearings are greasable, but require only minimal grease.

Recommended greasing is one small stroke every month. Be careful not to over-grease as this may push the seal out.

4. Replace and repair broken fittings immediately.
5. If fittings will not take grease, remove and clean thoroughly. Also clean lubricant passageway. Replace fitting if necessary.

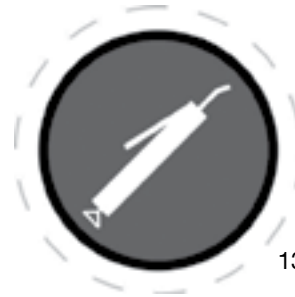

1300006014

Fig 34 - Lubricate decal

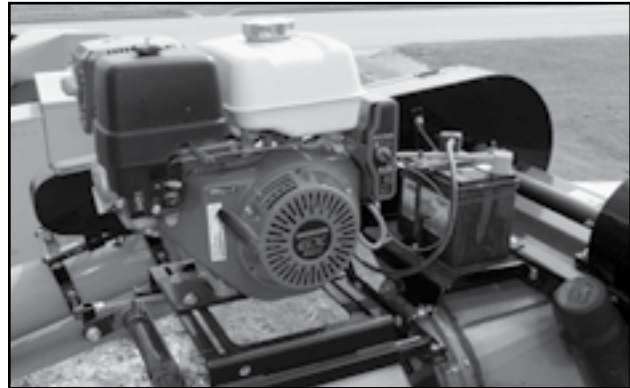

Fig 33 - Gas engine with electric start

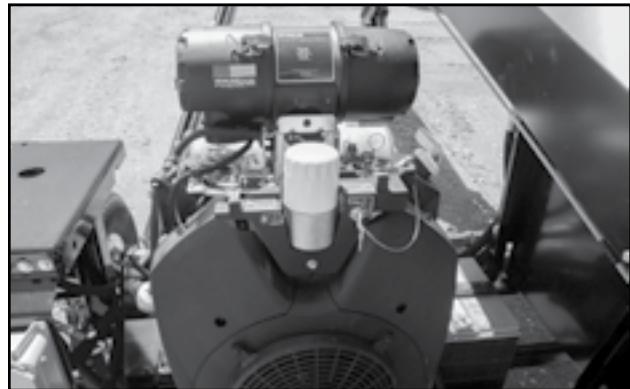

Fig 35 - Gas Engine

4.2 SERVICING INTERVALS

Use the Service Record provided on page 4-13, to keep a record of all scheduled maintenance.

The conveyor belt alignment is preset to run true under a condition of no load. It is important to check alignment and make adjustments, if required, during the initial few minutes of loaded operation.

Check bearings for wear daily.

The following recommended periods are based on normal operating conditions. Severe or unusual conditions may require more frequent lubrication and oil changes.

Schedules may vary depending on options and engine model contained in the present unit.

IMPORTANT:

For engine servicing and maintenance, refer to its manual for complete details.

4.2.1 Every 10 Hours or Daily:

Gas Engine Units:

1. Check fuel level on units with gas engine.
 - Add as required.
2. Check oil level on units with gas engine.
 - Add as required.
 -

All Conveyors:

3. Inspect conveyor belt lacing for wear.
4. Check the conveyor belt tension daily while breaking-in the conveyor.
 - Refer to Section 4.2.2
5. Check the conveyor belt alignment frequently during the first 10 hours of operation until it seats itself. Refer to Section 4.2.2



Fig 36 - Gas engine



Fig 37 - Transition roller bearings



Fig 38 - Discharge roller bearings

6. Inspect all rollers and bearings for play and wear.
 - Replace if necessary.

4.2.2 Every 50 Hours or Weekly:

7. Check the conveyor belt tension.

Watch the tension more often while breaking-in the conveyor, because the belt may stretch. Refer to Section 4.3.1

Note:

A properly tensioned belt will not slip when in operation.

8. Check the conveyor belt alignment.
 - How the belt is aligned to the rollers must be checked at the hopper, transition, at the drive box and the discharge.

Watch the alignment more frequently during the first 10 hours of operation. It usually seats itself and can be checked weekly after that. Refer to Section 4.3.2

9. Check the condition of the rubber, hopper flashing. Be sure it still seals the hopper to prevent leaking.

If any product comes out of the hopper around the flashing, loosen flashing mounting screws and adjust. Retighten anchor screws and try running the conveyor again. Repeat until no grain is lost.

If the flashing is stuck to the belt, manually peel the flashing up and off the hopper. Replace it if necessary.



Fig 39 - Hopper roller bearing

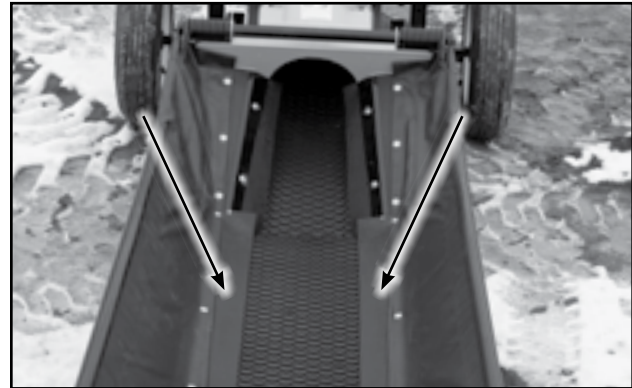

Fig 40 - Hopper flashing



Fig 41 - Hydraulic drive

Hydraulic Motor Units:

10. Inspect the coupler between the hydraulic motor and drive roller for wear.
11. Oil hydraulic drive coupler or chain.

4.2.3 Every 100 Hours or Monthly:**Note:**

Recommended greasing is one small stroke every month. Be careful not to over grease as this may push the seal out.

12. Grease hopper roller bearings.
13. Grease transition roller bearings, if equipped.
- 6 locations.
14. Grease discharge roller bearings.

Gas Engine and Electric Motor Units:

15. Grease countershaft bearings, if equipped.
16. Check drive belt tension and alignment.
Refer to Section 4.3.4 and 4.3.5
17. Clean air filter. Refer to Section 4.3.9

Hydraulic Drive Units:

18. Oil input drive coupler.

"GN" Models:

19. Check hold-down wheels for wear on rubber wrap. Replace if necessary.
Refer to Section 4.3.7

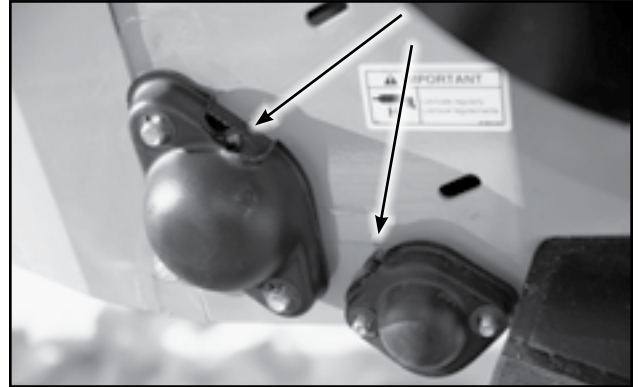

Fig 42 - Bearing grease zerks

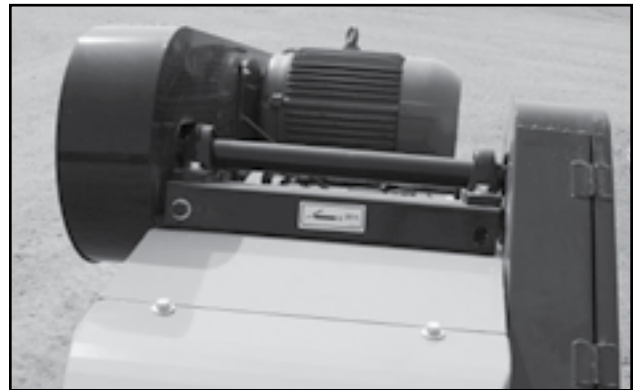

Fig 43 - Countershaft

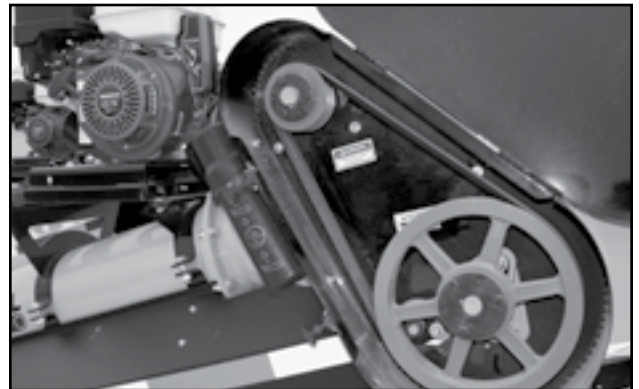

Fig 44 - Drive belt



Fig 45 - Hold-down wheels on Gooseneck hopper

4.2.4 Every 200 hours or Annually:

Gas Engine Units:

20. Refer to the engine manual for specific service and maintenance schedules.



Fig 46 - Gas engine



Fig 47 - Air filter

21. Repack wheel bearings.

22. Check tire air pressure.

23. Torque wheel bolts.



Fig 48 - Wheels

24. Wash the entire machine thoroughly using a water hose or pressure washer to remove all dirt, mud, debris and residue.

- Wash the outside.
- Wash around the hopper..
- Run the conveyor belt, while washing inside the tube and around the belt.



Fig 49 - Clean conveyor

4.3 MAINTENANCE PROCEDURES

By following a careful service and maintenance program for your machine, you will enjoy many years of trouble-free service.

Note:

Refer to the engine manual for complete details on your particular model.

⚠ WARNING

ROTATING PART HAZARD

Turn off engine/motor, lock-out power, wait for all components to stop moving before adjusting the belt.

To check belt position, idle engine, then rotate the belt slowly.



Fig 50 - Roller bearing mounts and anchor bolts

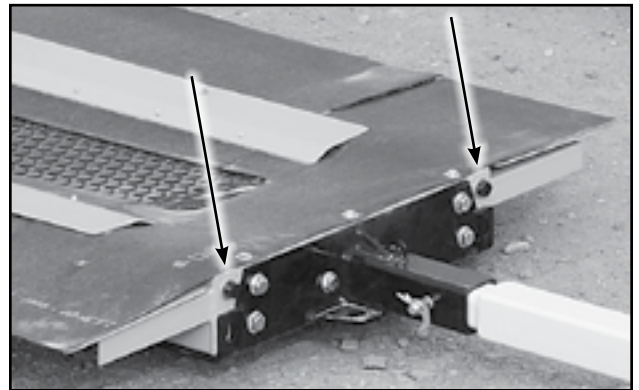

Fig 51 - Adjustment bolts on railcar hopper

4.3.1 Conveying Belt Tension:

The tension of the belt should be checked daily, or more often if required, to be sure that it does not slip under load.

To maintain the belt, follow this procedure:

1. Loosen the roller bearing housing bolts.
2. Rotate the adjustment bolts to correct the belt's tension.
3. Tighten the roller bearing housings.

IMPORTANT:

Adjust both sides equally.

Note:

To measure the belt tension, push on the underside of the belt. It should move up to 4" (10cm). Any more than that and the belt needs more tension.

4.3.2 Conveyor Belt Alignment:**NOTICE****BELT DAMAGE HAZARD**

Alignment of the belt must be checked at the hopper, transition and discharge. Inspect weekly. Unaligned belt will cause damage and void warranty.

NOTICE**BEARING FAILURE**

If a roller is replaced, ensure both ends are evenly aligned with the frame before running. If not, bearing failure may occur.

The belt is properly aligned when it runs in the centre of all.

Check frequently during the first few minutes of operation with a new belt, and then several times during the first 10 hours.

The new belt normally seats itself during the first 10 hours of operation and can be checked weekly after that.

⚠ WARNING**ROTATING BELT HAZARD**

To check belt position, idle engine, then rotate the belt slowly.
Turn off engine when adjusting rollers.

Note:

If belt is out of alignment, it will move to the loose side.
Tighten loose side or loosen tight side.

Belt Alignment at Tail and Transition Rollers:

1. Rotate the conveyor belt slowly, and check the position of the belt on the tail roller.

Note:

Adjust one side of roller at a time.

2. Depending on the model:
 - Move the bearing housing slightly.
 - or -
 - Tighten or loosen the adjustment bolt by 1/4 turn to 2 turns.
3. Tighten bearing housing.
4. Rotate the conveyor belt slowly, and check the position of the belt on the tail roller.
 - Repeat steps until the belt is centred.
5. When aligned, attach the housing guard.

Belt Alignment at Discharge/Drive Roller:

6. If necessary, remove the discharge spout to view the roller.
7. Adjust one side of roller at a time.
 - Loosen the bearing housing, then adjust.
8. Tighten the discharge roller bearing housing.
9. Run the belt a couple of revolutions and check the alignment.
 - Repeat steps until the belt runs centred.
10. Replace the bearing housing guard.
11. If removed, reattach the discharge spout.

4.3.3 Conveyor Belt Replacement:

1. Rotate the conveyor belt until the Alligator® lacing is positioned under the tube and is accessible.
2. Move the tail roller bearings to their loosest position.
3. Pull all the slack to the seam area.
4. Remove the lacing rod and open the belt.
5. Attach the new belt to the end of the existing belt which is hanging closest to the hopper.
6. Pull the end of the old belt which is coming from the direction of the discharge hood. The new belt will follow and be threaded into place.
7. Disconnect the old belt.
8. Link the ends of the new belt lacing.
9. Work the lacing cable through the lacing to fasten the belt.



Fig 52 - Tail roller bearing housing

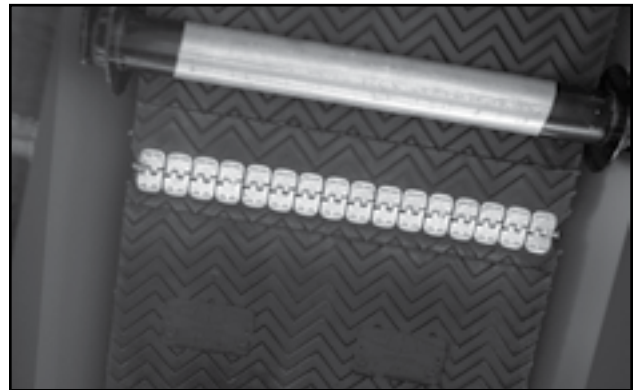

Fig 53 - Conveyor belt seam under tube

Note:

Cordless drill can be used to thread cable.
Proceed slowly.

10. Cut off the excess cable.
11. Crimp lacing at both ends to lock cable in place.
12. Cut and taper the trailing corner of the belt.
 - This will keep the hole as small as possible.
 - Tapered corner won't catch when running.
13. Set the belt tension. Refer to Section 4.3.1
14. Set the belt alignment. Refer to Section 4.3.2.

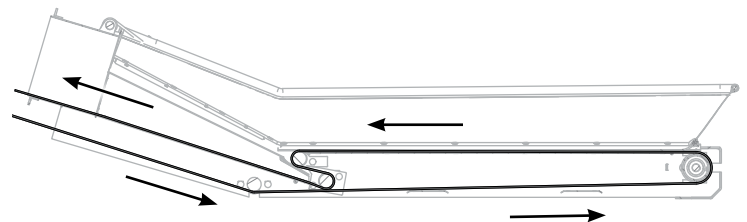

Fig 54 - S-Neck belt path

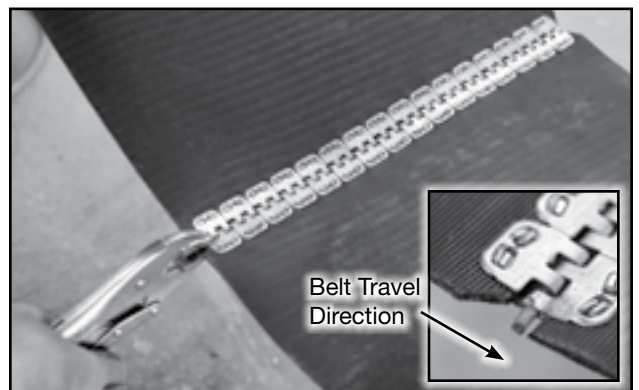

Fig 55 - Belt lacing

4.3.4 Drive Belt Tension:

To adjust drive belt tension, follow this procedure:

⚠ WARNING

ROTATING PART HAZARD

Turn off engine or motor, remove power supply and wait for all belts to stop rotating.

First, Tension “Countershaft to Drive” Belt:

1. Open the guard over the V-belt pulleys.
2. Loosen countershaft bearing mount anchor bolts and lock nuts.
3. Use bearing mount position bolts to adjust countershaft position and set belt tension.

Calculate the tension. See Figure 55:

- Measure length of span between pulleys
- Allow 1/64” of deflection per inch of span

4. Tighten bearing mount anchor bolts.
5. Tighten lock nuts on the adjusting bolts.
6. Close and secure guard over pulleys.

Second, Tension “Engine to Countershaft” Belt:

7. Open the guard over the V-belt pulleys.
8. Loosen engine/motor mount bolts and lock nuts.
9. Use motor mount bolts to set belt tension.

Calculate the tension. See Figure 58:

- Measure length of span between pulleys
- Allow 1/64” of deflection per inch of span

10. Tighten motor mount anchor bolts.
11. Tighten lock nuts on the adjusting bolts.
12. Close and secure guard over pulleys.

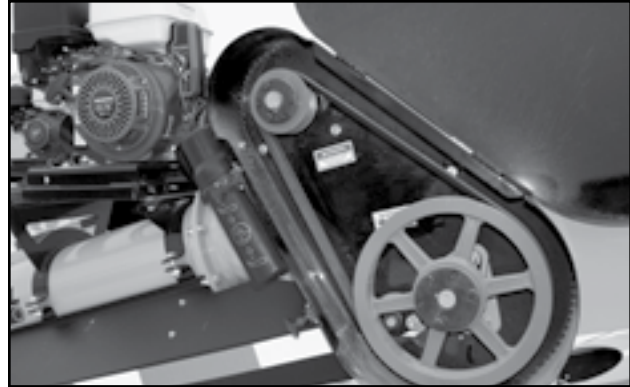

Fig 56 - Countershaft to drive roller V-belt

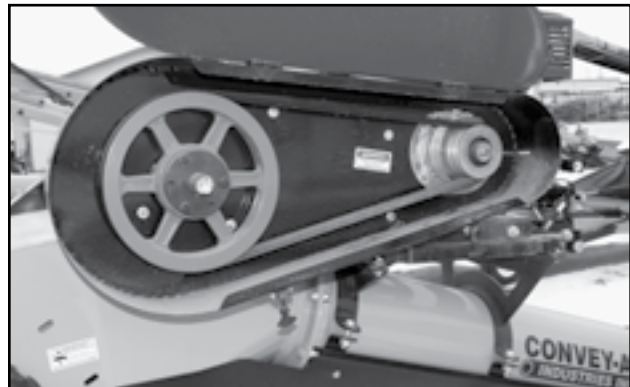

Fig 57 - Engine to countershaft V-belt

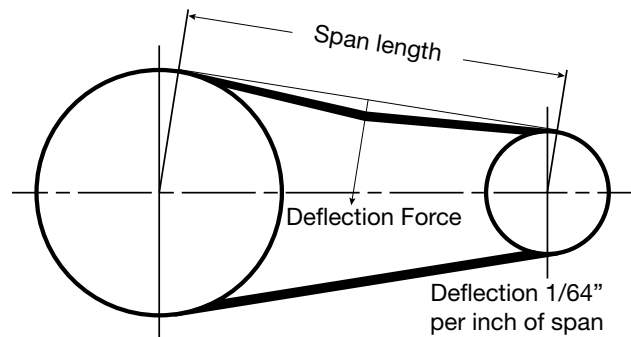

Fig 58 - Tension calculation



Fig 59 - Electric motor, speed reduction drive

4.3.5 Check Pulley Alignment:

1. Use a straight edge across both drive and driven pulleys to check alignment.
2. Use tapered lock hub in the center of pulley to adjust the position of a pulley, if required.
3. Move a pulley to align if there is more than a 1/32 inch gap between the edge of the pulley and the straight edge.

4.3.6 Drive Belt Replacement:

1. Place drive system into its loosest position.
2. Remove old belt.
3. Install replacement belt.
4. Set belt tension. See Figure 55
5. Check pulley alignment.

4.3.7 "GN" Hold Down Wheels Replacement:

1. Remove transition cover. See Figure 27
2. Remove bolts which face the open hopper (a). There are two bolts on either side.
3. Remove bolts which are inside the tube (b). One on either side.
4. Now, these side brackets are loose, but still attached to the hopper flashing. Folded both sides out, to lay on hopper. This will give access to the wheels.
5. Remove bolts, then remove worn wheels (c).
6. Insert the new wheels and tighten bolts.
7. Fold side brackets back into place. Bolt and tighten.
8. Secure transition cover to guard hopper transition.

Cross Section	Smallest Sheave Diameter Range	RPM Range	Belt Deflection (Force Pounds)			
			Uncogged Hy-T® Belts and Uncogged Hy-T® Torque Team®		Cogged Torque Flex® and Machined Edge Torque Team® Belts	
			Used Belt	New Belt	Used Belt	New Belt
A, AX	3.0 - 3.6	1000-2500 2501-4000	3.7 2.8	5.5 4.2	4.1 3.4	6.1 5.0
	3.8 - 4.8	1000-2500 2501-4000	4.5 3.8	6.8 5.7	5.0 4.3	7.4 6.4
	5.0 - 7.0	1000-2500 2501-4000	5.4 4.7	8.0 7.0	5.7 5.1	9.4 7.6
B, BX	3.4 - 4.2	860-2500 2501-4000	n/a	n/a	4.9 4.2	7.2 6.2
	4.4 - 5.6	860-2500 2501-4000	5.3 4.5	7.9 6.7	7.1 6.2	10.5 9.1
	5.8 - 8.6	860-2500 2501-4000	6.3 6.0	9.4 8.9	8.5 7.3	12.6 10.9
C, CX	7.0 - 9.0	500-1740 1741-3000	11.5 9.4	17.0 13.8	14.7 11.9	21.8 17.5
	9.5 - 16.0	500-1740 1741-3000	14.1 12.5	21.0 18.5	15.9 14.6	23.5 21.6
D	12.0 - 16.0	200-850 851-1500	24.9 21.2	37.0 31.3	n/a	n/a
	18.0 - 20.0	200-850 851-1500	30.4 25.6	45.2 38.0	n/a	n/a
			Uncogged Hy-T® Wedge Belts and Uncogged Hy-T® Wedge Torque Team®		Cogged Hy-T® Wedge Belts and Hy-T® Wedge Machine Edge Torque Team®	
			Used Belt	New Belt	Used Belt	New Belt
5V	4.4 - 6.7	500-1749 1750-3000 3001-4000	n/a	n/a	10.2 8.8 5.6	15.2 13.2 8.5
	7.1 - 10.9	500-1740 1741-3000	12.7 11.2	18.9 16.7	14.8 13.7	22.1 20.1
	11.8 - 16.0	500-1740 1741-3000	15.5 14.6	23.4 21.8	17.1 16.8	25.5 25.0

Table 2 - Belt deflection force

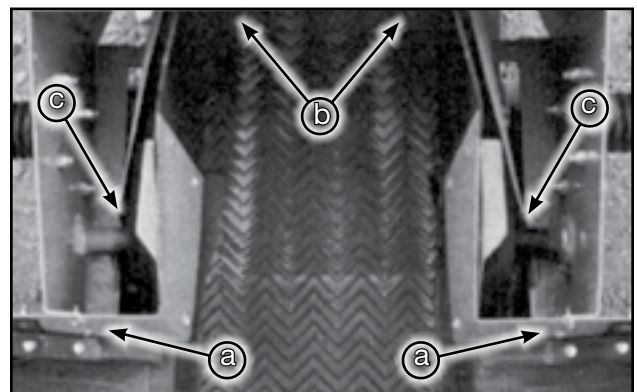

Fig 60 - Bolts facing hopper (a), bolts inside (b), wheels (c)

This page intentionally left blank

4.4 SERVICE RECORD

See Section 4.2 for service intervals. This schedule is only a general guide under good conditions. Under extreme, or unusual circumstances adjust service timing accordingly.

For more detailed schedule pertaining to the specific engine/motor model, consult its manual.

Copy this page to continue record.

Maintenance	Hours																		
	Serviced By																		
10 Hours or Daily																			
Check Fuel Level																			
Check Engine Oil Level																			
Inspect Belt Lacing																			
Inspect Rollers and Bearings																			
50 Hours or Weekly																			
Check Conveyor Belt Tension																			
Check Conveyor Belt Alignment																			
Check Hopper Flashing																			
Check Drive Belt Tension and Alignment																			
Inspect Hydraulic Drive Coupler																			
100 Hours or Monthly																			
Grease All Roller Bearings																			
Grease Countershaft																			
Clean Air Filter																			
Oil Hydraulic Drive Coupler																			
Check Gooseneck Hold-Down Wheels																			
200 Hours or Annually																			
Change Engine Oil and Filter																			
Change Air Filter																			
Repack Wheel Bearings																			
Check Tire Pressure																			
Torque Wheel Bolts																			
Wash Machine																			

4.5 ORDERING PARTS

Always give the Model Number and Serial Number when ordering parts.

To get your parts promptly the following information will be required:

- The part name and number
- Your Name, Address, Town, Province/State, Country
- Complete information for shipping

Confirm all phoned in orders in writing. If Purchase Orders are required please note the number on the written order.

Unless claims for shortages or errors are made immediately upon receipt of goods, they will not be considered.

Inspect all goods received immediately upon receipt. When damaged goods are received, insist that a full description of the damage is made with the carrier against the freight bill. If this is insisted upon, full damage can be collected from the transport company.

No responsibility is assumed for delay or damage to merchandise while in transit. Dealers responsibility ceases upon delivery or pickup of shipment from or to the transportation company. Any freight damage claims must be made with the transportation company, not with the dealer.

Section 5: TROUBLESHOOTING

In this section is a list of common problems, causes and solutions which may be encountered.

If you have a problem which is difficult to solve, even after having read through this section, please contact your authorized dealer, distributor or the Meridian Manufacturing Inc. Before you call, please have this Operator's Manual and the unit's serial number ready.

Problem

Possible Cause	Possible Solution
-----------------------	--------------------------

Engine won't start

Low battery	Recharge or replace
No fuel	Refuel
Air cleaner dirty	Clean the air cleaner, and/or replace the air filter

Hydraulic system - No hydraulic flow

Flow valve closed or plugged	Open flow circuit valve
	Replace plugged hydraulic filter

Engine/Motor labouring

Belt is sticky on the back side, because of oily product or wet/snowy conditions	Clean the belt
Hopper flashing too tight	Adjust to loosen the flashing

Conveyor belt doesn't turn or is slipping

Hopper flashing may be stuck to belt, because it is running dry and rubber is heating up	Turn off unit! Manually peel flashing up and off hopper. Then run dry product through to create barrier between flashing and belt
Belt loose	Tighten and align
Conveyor belt loose because it has stretched	Shorten belt
Belt frozen to tube from operating in high humidity conditions in extreme cold	Remove conveyor from area of high humidity and continue to run empty so the belt dries prior to freezing.
Gas/Electric system - Drive belt loose	Tighten drive belt
Gas/Electric system - Drive roller is slipping	Replace V-belt

continued on next page

Problem

Possible Cause	Possible Solution
-----------------------	--------------------------

Conveyor belt doesn't turn or is slipping - cont'd

Hydraulic system - valve, pump or motor could be malfunctioning	Check and adjust pressure set screw on valve. Test flow from pump. Check for oil leaks under motor. Replace what is needed.
Seized bearing	Check all bearings, Replace any that are rough or seized
Belt/Roller is jammed	Check for sticks, stones, other objects jammed in belt drive area and remove.

Conveyor belt doesn't track correctly

Roller lagging may be worn	Replace roller or have it re-lagged
----------------------------	-------------------------------------

Conveyor Belt Fraying

Belt not aligned	Align and adjust tension
------------------	--------------------------

Product leakage

Product may be getting under the belt at the hopper, traveling up inside the belt and leaking off discharge end	Replace hopper flashing
---	-------------------------

Low conveying capacity

Gas/Electric system - drive roller is slipping	Replace V-belt
Conveyor belt slipping	Tighten and align

Section 6: REFERENCE

For information not included here, or for a digital copy of this manual, please call your dealer or Meridian Manufacturing Inc. directly for assistance (1-800-418-9461).

Specifications and measurements subject to change without notice.

6.1 SPECIFICATIONS

MODEL	DISCHARGE HEIGHT TO GROUND	HOPPER TO GROUND	OVERALL LENGTH	HOPPER LENGTH	TUBE DIAMETER	BELT WIDTH
1214-GN	36" - 48"	61/2"	15' 4"	4' 9"	10"	12"
1615	38" - 48"	61/2" - 73/4"	17' 4"	5' 10"	10"	16"
1616-RC	36" - 48"	45/8"	20'	7'	10"	16"
2218	38" - 48"	61/2" - 73/4"	20' 2"	5' 10"	14"	22"
2218-RC	36" - 48"	45/8"	21' 6"	7'	14"	22"

Table 3 - Specifications

6.2 BOLT TORQUE

The tables shown below give correct torque values for various bolts and capscrews. Tighten all bolts to the torques specified in chart unless otherwise noted. Check tightness of bolts periodically, using bolt torque chart as a guide. Replace hardware with the same strength bolt.

ENGLISH TORQUE SPECIFICATIONS						
Bolt Diameter "A"	Bolt Torque*					
	SAE 2		SAE 5		SAE 8	
	(Nm)	(ft-lb)	(Nm)	(ft-lb)	(Nm)	(ft-lb)
1/4"	8	6	12	9	17	12
5/16"	13	10	25	19	36	27
3/8"	27	20	45	33	63	45
7/16"	41	30	72	53	100	75
1/2"	61	45	110	80	155	115
9/16"	95	60	155	115	220	165
5/8"	128	95	215	160	305	220
3/4"	225	165	390	290	540	400
7/8"	230	170	570	420	880	650
1"	345	225	850	630	1320	970

Table 4 - English Torque

METRIC TORQUE SPECIFICATIONS				
Bolt Diameter "A"	Bolt Torque*			
	8.8		10.9	
	(Nm)	(ft-lb)	(Nm)	(ft-lb)
M3	0.5	0.4	1.8	1.3
M4	3	2.2	4.5	3.3
M5	6	4	9	7
M6	10	7	15	11
M8	25	18	35	26
M10	50	37	70	52
M12	90	66	125	92
M14	140	103	200	148
M16	225	166	310	229
M20	435	321	610	450
M24	750	553	1050	774
M30	1495	1103	2100	1550
M36	2600	1917	3675	2710

Table 5 - Metric Torque

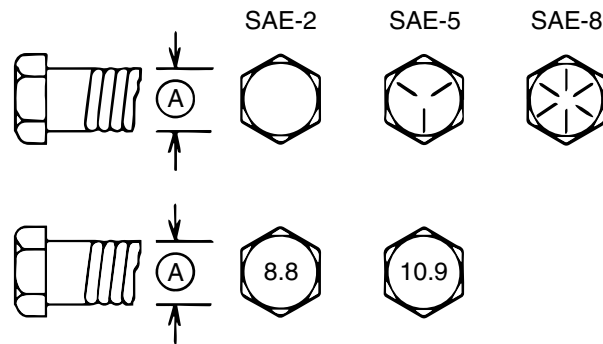

Torque figures indicated above are valid for non-greased or non-oiled threads and heads unless otherwise specified. Therefore, do not grease or oil bolts or capscrews unless otherwise specified in this manual. When using locking elements, increase torque values by 5%.

* Torque value for bolts and capscrews are identified by their head markings.

This page intentionally left blank

LIMITED WARRANTY STATEMENT

1. Meridian Manufacturing Inc, hereafter referred to as Meridian®, warrants each new product (the "Goods") to be free from defects in material and workmanship under normal use and service for a period of one (1) year or ninety (90) days in the case of commercial use, from the shipment date from the Meridian dealer (FCA).
2. Meridian® warrants replacement parts and components either manufactured or sold by, will be free from defects in materials or workmanship under normal use and service for thirty (30) days from the shipment date from the Meridian dealer (FCA), or the remainder of the original warranty period on the Goods, whichever is longer.
3. This warranty does not apply to:
 - a. To any merchandise or components thereof, which in the sole and unfettered opinion of Meridian®, have been subject to misuse, unauthorized modifications, alteration, accident, negligence, product abuse or lack of required maintenance.
 - b. If repairs have been made with parts or by persons other than those parts or persons approved by Meridian®.
 - c. To parts and accessories not manufactured by Meridian® including, but not limited to, engines, batteries, tires, belts, PTO shafts or other trade accessories. Such parts shall be covered by the warranty given by the actual manufacturer, if any.
 - d. To failure of parts; or failure of parts to perform due to wear under normal or excessive service conditions; or to failure due to use by the Purchaser for purposes other than originally intended at time of manufacture, including without limitation using the Goods for mixing fertilizer, etc.; or used in excess of the built specifications.
 - e. To Goods used in areas exposed to corrosive or aggressive conditions including, but not limited to, salt water from either inside or outside the Goods.
 - f. To failures or defects arising out of damage during shipment or during storage.
 - g. To materials replaced or repaired under this warranty, except to the extent of the remainder of the applicable warranty.
4. The obligation of Meridian® under this warranty shall not arise unless Meridian® is notified and this warranty is presented together with a written statement specifying the claim or defect within thirty (30) days after the failure is first detected or made known to the Purchaser and within: (i) one (1) year, or ninety (90) days in the case of commercial use; or (ii) thirty (30) days in the case of replacement parts and components manufactured by Meridian®; from the shipment date from the Meridian dealer (FCA). Meridian® in its sole and unfettered discretion shall determine if the claim is valid and whether correction of the defect or failure shall be made by repair or replacement of the materials.
5. Title to any replaced materials Meridian® wishes to have pass to it, shall pass to Meridian®.
6. The obligation of Meridian® hereunder extends only to the original Purchaser or Buyer to whom the Goods were initially sold. This warranty shall not be subject to any assignment or transfer without the written consent of Meridian®.
7. The purchaser acknowledges that it has made its own independent decision to approve the use of the Goods and also the specific fabrication and construction procedures utilized to complete the Goods, and has satisfied itself as to the suitability of these products for its use.

8. This warranty is subject to the following limitations, provisions and conditions:
 - a. Meridian® shall have no liability hereunder for any claims, including field re-work.
 - b. Meridian® shall not be liable for any incidental loss or damage, however caused, including, without limitation, normal wear and tear.
 - c. Meridian® makes no express or implied warranties of any nature whatsoever except for such express warranties as set out herein. The warranty provided herein is in lieu of and excludes all other warranties, guarantees or conditions pertaining to the Goods, written or oral, statutory, express or implied, (except the warranty as to title) including any warranty as to the merchantability or fitness for any particular purpose. Meridian® expressly disclaims all other representations, conditions or warranties, expressed or implied, statutory or otherwise and any representations, warranties or conditions that may arise from a course of dealing or usage of trade. The warranty provided herein shall constitute Meridian's sole obligation and liability and the Purchaser's sole remedy for breach of warranty. No other warranty has been made by any employee, agent, or representative of Meridian® and any statements contained in any other printed material of Meridian® is expressly excluded here from. Meridian® shall not be responsible for any warranty offered by the Purchaser to its customers with respect to the Goods and the Purchaser shall indemnify Meridian® with respect to same if any of those customers makes a claim against Meridian® relating to any such warranty.
 - d. Subject to Meridian's obligations contained in paragraphs 1 and 2 herein, none of Meridian®, its officers, directors, servants or agents shall be liable, or responsible for any loss or damage (including strict liability and liability for loss or damage due to items which the manufacturing processes are designed to identify) whether such loss or damage is caused by negligence in any manner whatsoever (including gross negligence, error, misrepresentation, misstatement, imprudence, lack of skill or lack of judgement).
9. The sole financial obligation of Meridian® under this warranty shall be limited to the repair or replacement of the Goods as originally supplied and in no event shall they exceed the original cost of the Goods supplied.
10. Meridian® shall not have any obligation under any warranty herein until all accounts have been paid in full by the Purchaser.
11. The construction and interpretation of this Warranty shall be governed by the laws of the Province of Manitoba.

WARRANTY CLAIM PROCEDURE

1. The goods must be registered with Meridian®.
2. The purchaser must contact the dealer, from where the unit was purchased, immediately upon discovery of any defects.
3. A completed warranty claim form must be submitted by the dealer to Meridian's warranty representative for review and any subsequent course of action.
 - Warranty claims must be completed with ALL required information in order it to be accepted.
 - Send photographs of the entire piece of equipment, and of the specific area of concern.
4. Warranty repair work will only be performed by Meridian® or an approved representative of Meridian®. No warranty work completed prior to approval by Meridian® will be honoured. Failure to follow procedure may affect any or all of this warranty.
5. All warranty claims will be adjudicated at the sole discretion of Meridian® and in accordance with the terms and conditions of the limited warranty.

CONVEY-ALL™

(800) 418-9461 | www.convey-all.com | conveyors@convey-all.com